

BMT Introduction

Best and Most Trusted Industrial Fittings & Valves

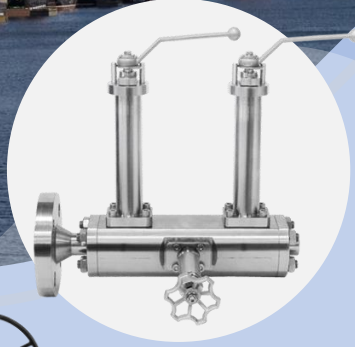



Table of Contents

01 About BMT

Company Profile
History
Organization
Global Network

Page 3
Page 4
Page 5
Page 6

02 Products & Facilities

Product Overview
Product Specification
Facilities & Capacity
Test/Inspection Equipment
R&D Capabilities



Page 7 - 8
Page 9 - 27
Page 28 - 29
Page 30 - 33
Page 34- 35

03 Certifications & Experiences

Certification
Vendor Registration
List of experience

Page 36 - 37
Page 38 - 40
Page 41 - 66

Company Profile

Company Name	BMT Co., Ltd.	Brand	 
Business Division	<ul style="list-style-type: none"> • (90%) Fittings & Valves • (10%) Electric Products & Energy Solutions 		
Founder/CEO	Yoon, Jongchan	Establishment	1988 (Incorporation in 2000)
Legal Entity Type	Publicly Traded Company (KOSDAQ)	CR#	606-81-28130
Certificates	ISO9001, ISO14001, ISO45001		
Sales (Million USD) *	109.5 (2022), 94.2 (2021), 74.7 (2020)	Credit Rating	A- (KODATA, April 2023)
Location (Fittings & Valves Division)	<ul style="list-style-type: none"> • HQ & Factory: 17, Sinsojaesandan 2-ro, Jangan-eup, Gijang-gun, Busan, 46031 South Korea • Seoul Office: 701, 1130, Beom an-ro, Geumcheon-gu, Seoul, 08595 S Korea 		
Number of Employees	361 (as of Mar 2023)		
Contact (Int'l Sales)	TEL: + 82 (0)51 780 5000 E-MAIL: superlok@superlok.com		
Web Site	http://www.superlok.com		

Histoty

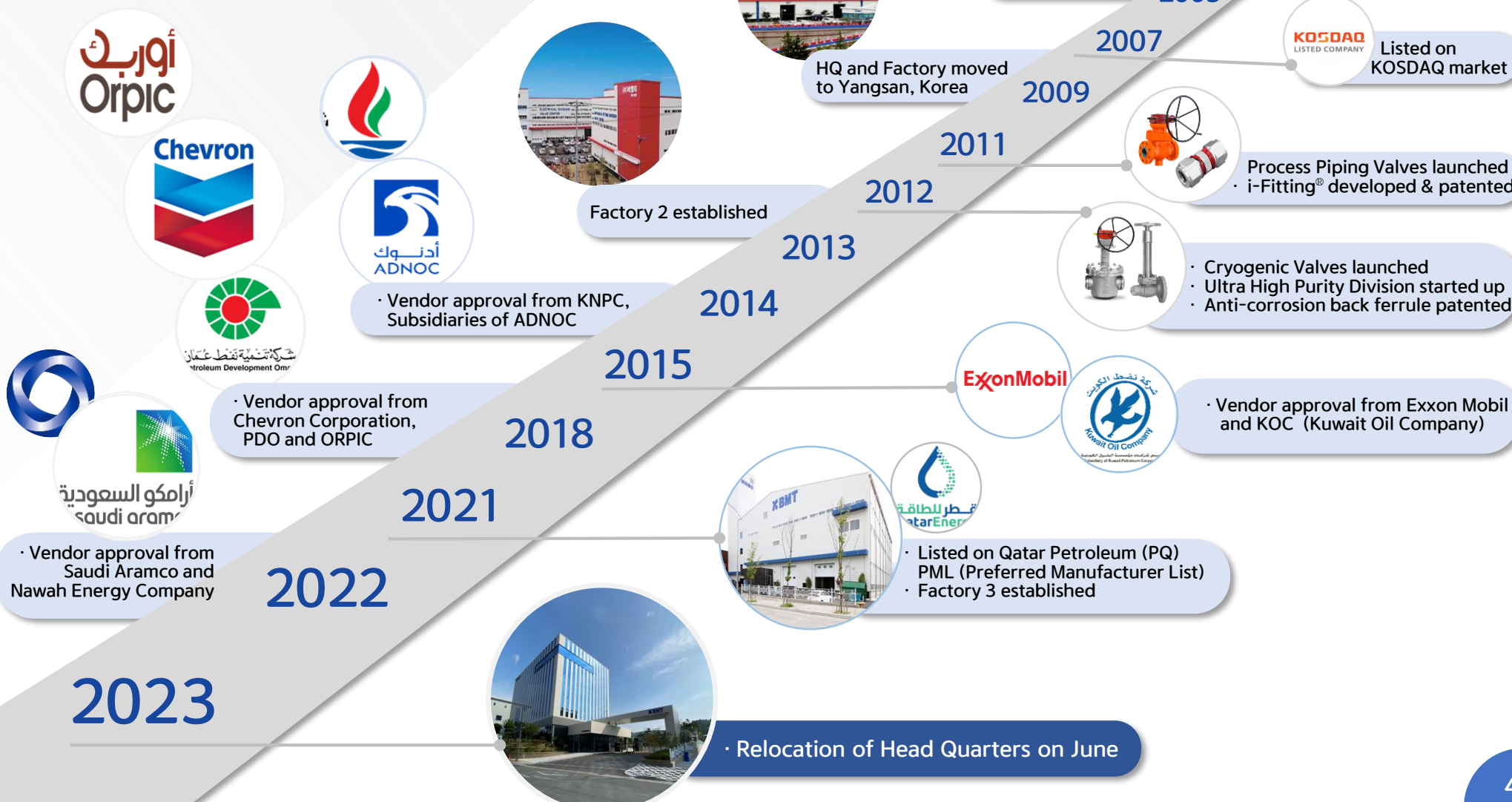

Gyeong Pung Machinery Co. established 1988

BMT
Legally incorporated (BMT Co., Ltd.)

2000



BMT R&D Center established

2005



HQ and Factory moved to Yangsan, Korea

2007

KOSDAQ
LISTED COMPANY
Listed on KOSDAQ market

2009



Factory 2 established

2011



Process Piping Valves launched
i-Fitting® developed & patented

2012



Cryogenic Valves launched
Ultra High Purity Division started up
Anti-corrosion back ferrule patented

2013

2014

Vendor approval from KNPC, Subsidiaries of ADNOC

2015

ExxonMobil



Vendor approval from Exxon Mobil and KOC (Kuwait Oil Company)

2018

Vendor approval from Chevron Corporation, PDO and ORPIC

2021



Listed on Qatar Petroleum (PQ) PML (Preferred Manufacturer List)
Factory 3 established

2022

Vendor approval from Saudi Aramco and Nawah Energy Company

2023



Relocation of Head Quarters on June



BMT Organization

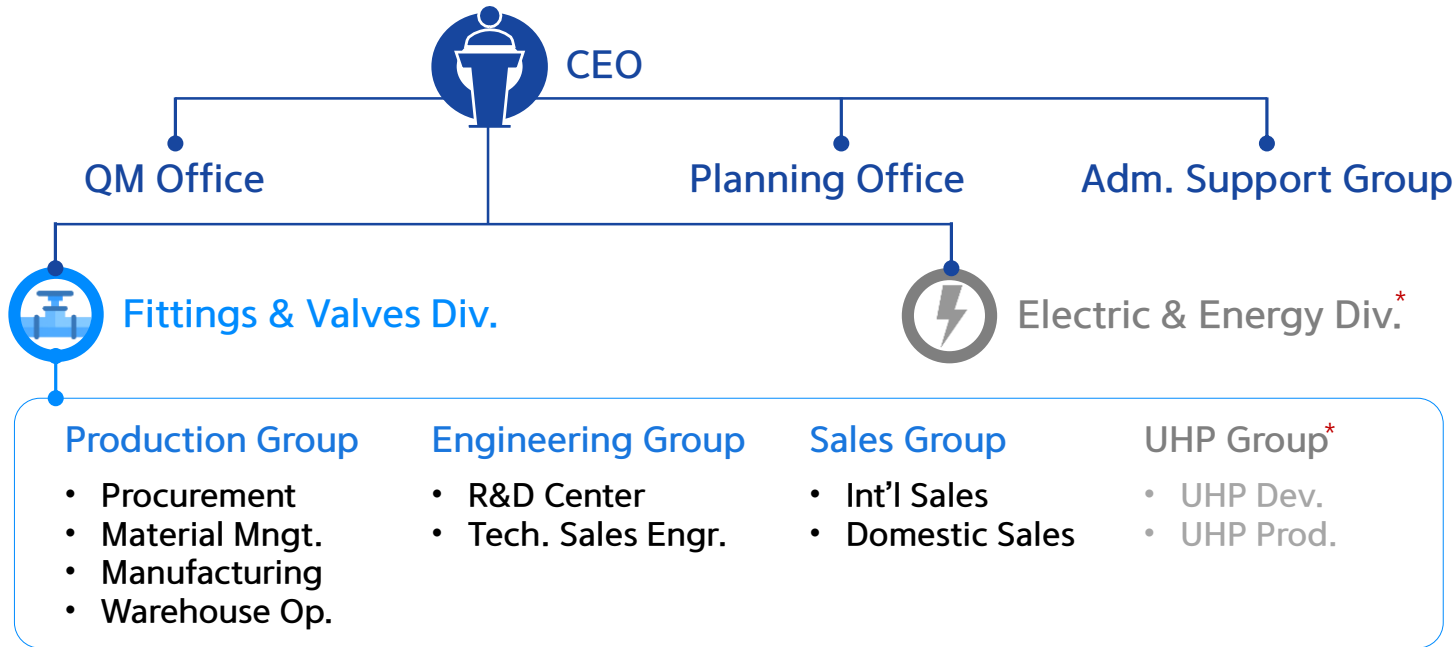

* Departments not relevant to this PQ are identified in grey texts

BMT HSE Committee



No. of Employees By Key Areas*

(as of March 2023)

R&D · Design · Engineering



Quality Mngt.



Process Mngt. · Production



SCM, Warehouse



Mngt. Support · Admin



Marketing · Sales



* Information in this page is to show the overall company organization, so that departments/persons both relevant and irrelevant to the evaluation might be included.

Global Network

BMT serves customers all over the world together with its 55 international Distributors in 29 Countries.

BMT Sales/Marketing Team

55 International Distributors

- FLOWSERVE
- Technip
- Chevron
- ADNOC
- كويت نفط الكويت (Kuwait Oil Company)
- JGC
- John crane
- BR
- PETROBRAS
- ExxonMobil
- PERTAMINA
- سابك (SABIC)
- اوربك (Orpic)
- Keppel
- Eni
- Saipem
- EMERSON
- PERTAMINA
- DOOSAN
- LARSEN & TOUBRO
- شركة تنمية نفط عمان (Petroleum Development Oman)
- قطر للبترول (Qatar Petroleum)
- ConocoPhillips
- posco
- HYUNDAI ENGINEERING & CONSTRUCTION
- غازпром (GAZPROM)
- شركة البترول الوطنية الكويتية (KNPC)
- سك E&C (SK E&C)
- DSME
- CPECC
- شركة نواة للطاقة (Nawah Energy Company)
- SAMSUNG
- SAMSUNG ENGINEERING
- GS E&C
- DAELIM
- Hanwha
- ABB
- TECNICAS REUNIDAS
- MAPNA GROUP

Product Overview

Piping Valve series



BLOCK & BLEED VALVES



CRYOGENIC VALVES

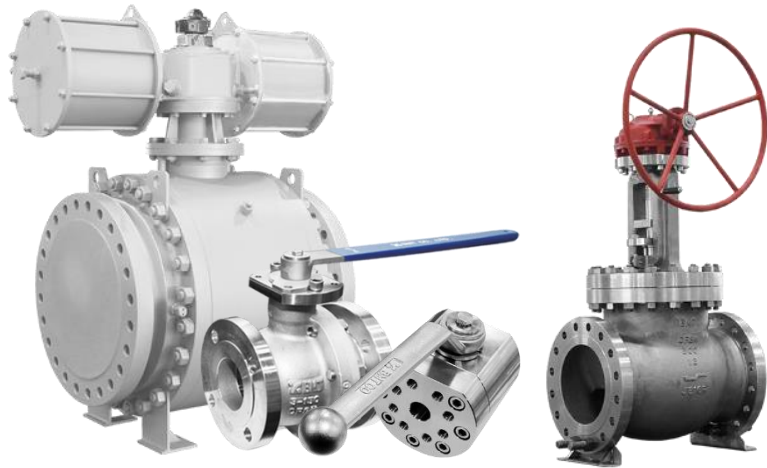

BALL & GLOBE VALVES



OTHER PRODUCT OFFERINGS

Product Overview

Instrument Valve series



INSTRUMENT BALL VALVES



HIGH PRESSURE VALVES



NEEDLE VALVES



CHECK VALVES

Fitting series



SUPERLOK TUBE FITTINGS
(Compression Type)



BITE TYPE TUBE FITTINGS
(STD: JIS B2351)



BITE TYPE TYBE FITTINGS
(STD: DIN 2353)



37° FLARED TUBE FITTINGS
(STD: SAE J514)



PIPE FITTINGS
(STD: ASME B1.20.1, SAE AS71051,
ISO 228/1, JIS B0202, ISO 7/1, JIS B0203)



O-RING FACE SEAL FITTINGS
(O-ring Face to Face Design)



HIGH PRESSURE FITTINGS
(Coned & Threaded Connection Design)



SPECIAL FITTINGS
(i-fittings & Pre-forming Fittings)

Product Specification

BMT Block & Bleed Valves incorporate up to 3 ball valves or mixture of ball and needle design into a single valve unit. One compact unit reduces the need for Large, Complicated, Costly Multi-Valve Systems. Removing Connections between separate units result in fewer potential leak paths. A vent valve allows to check the integrity of seat seals and permits withdrawal of fluid leakage increasing safety and ease of maintenance.

BLOCK & BLEED

CRYOGENIC

BALL & GLOBE

Piping Valve

Instrument Valve

Fitting

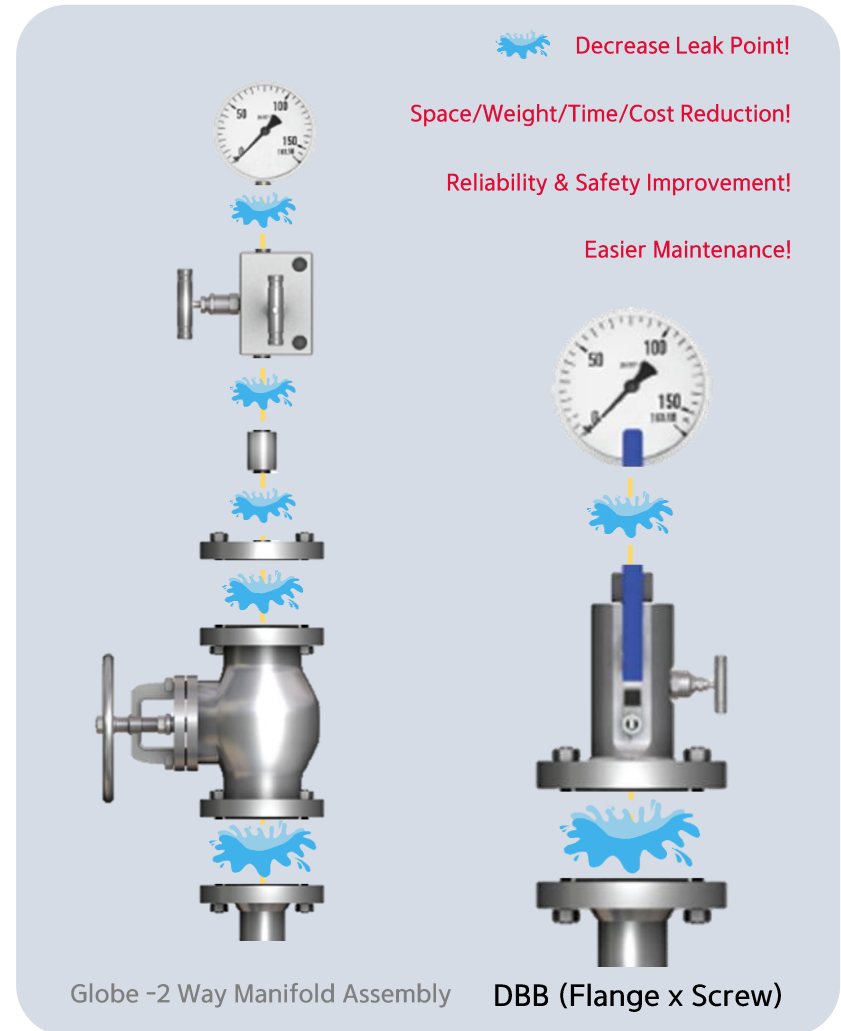
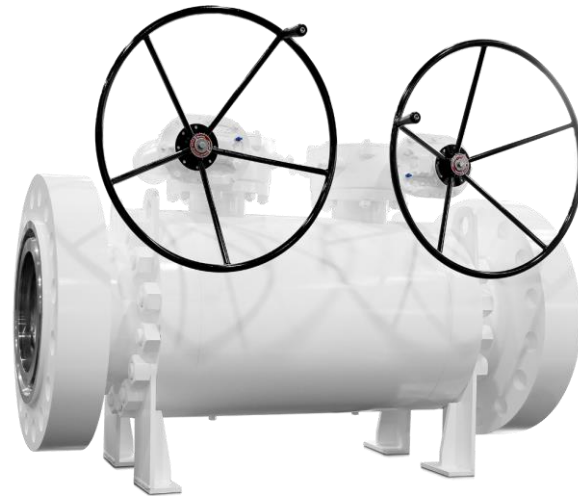

Product Specification

BLOCK & BLEED

CRYOGENIC

BALL & GLOBE

Piping Valve

Instrument Valve

Fitting

Single Block & Bleed (SBB) Valve

DESIGN SPECIFICATION

ASME B16.34, B16.5, B31.3, B1.20.1, API 6D

SIZE 1/2 to 16 in

BODY MATERIAL

I Carbon Steel:	A105, A350 LF2, A352 LCB/LCC, A216 WCB
I Stainless Steel:	ASTM A182 F316/316L/F51/F53, A351 CF8M/CF3M, A890 4A/6A
I Duplex:	A182 F51/F53
I Al-bronze Alloy:	B148, B150
I Inconel	625/825

ISOLATE TYPE

Ball, Needle (Optional: OS&Y)

BLEED VALVE TYPE

Ball, Needle (Optional: OS&Y)

BLEED CONNECTION

1/2" FNPT as standard, optional connections including Flange

TEMPERATURE

(Soft seated) -49 to 500°F(-45 to 260°C)
(Metal seated) up to 842°F(450°C)

PRESSURE RATING

CL150 to CL2,500



Double Block & Bleed (DBB) Valve

DESIGN SPECIFICATION

ASME B16.34, B16.5, B31.3, B1.20.1, API 6D

SIZE 1/2 to 16 in

BODY MATERIAL

I Carbon Steel:	A105, A350 LF2, A352 LCB/LCC, A216 WCB
I Stainless Steel:	ASTM A182 F316/316L/F51/F53, A351 CF8M/CF3M, A890 4A/6A
I Duplex:	A182 F51/F53
I Al-bronze Alloy:	B148, B150
I Inconel	625/825

END CONNECTION

Butt Weld, Socket Weld, Thread, Flange

ISOLATE TYPE (1st, 2nd)

Ball, Needle (Optional: OS&Y)

BLEED VALVE TYPE

Ball, Needle (Optional: OS&Y)

BLEED CONNECTION

1/2" FNPT as standard, optional connections including Flange

TEMPERATURE

(Soft seated) -49 to 500°F(-45 to 260°C)
(Metal seated) up to 842°F(450°C)

PRESSURE RATING

CL150 to CL2,500



Product Specification

BLOCK & BLEED

CRYOGENIC

BALL & GLOBE

Cryogenic Ball Valve

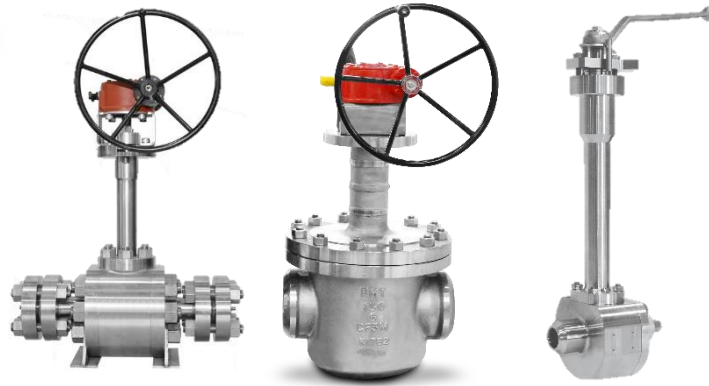

DESIGN SPECIFICATION

- | ASME B16.10, B16.11, B16.25, B16.5, B16.34
- | BS6364
- | API 6D

■ **SIZE** 1/2 to 14 in

BODY MATERIAL

Stainless Steel
(A182-F316, A182-F316L, A351-CF8M, A351-CF3M)

END CONNECTION

Butt weld, Socket weld, Thread, Flange

■ **TEMPERATURE** Down to -321°F(-196°C)

■ **PRESSURE RATING** CL150 to CL2,500

Cryogenic DBB Valve

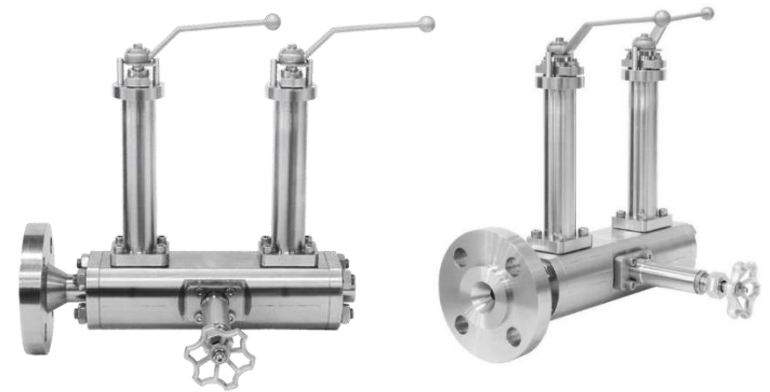

DESIGN SPECIFICATION

- | ASME B16.5, B16.34
- | API 6D
- | BS6364

■ **SIZE** 1/2 to 4 in

BODY MATERIAL

Stainless Steel
(A182-F316, A182-F316L, A351-CF8M, A351-CF3M)

■ **VALVE TYPE** Ball-Ball-Needle, Needle-Needle-Needle

■ **END CONNECTION** Flanged-Threaded, Flanged-Flanged

■ **TEMPERATURE** Down to -321°F(-196°C)

■ **PRESSURE RATING** CL150 to CL2,500

Product Specification

BLOCK & BLEED

CRYOGENIC

BALL & GLOBE

Cryogenic Needle Valve

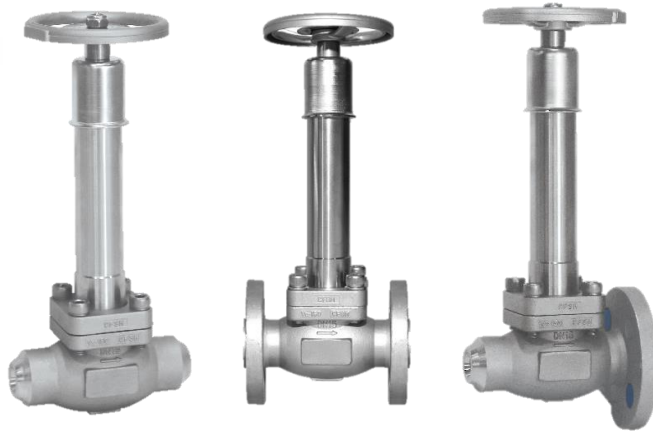

■ **DESIGN SPECIFICATION**

| ASME B16.34, B16.11, B16.25, B16.5

■ **SIZE**

1/2 to 1-1/2 in

■ **BODY MATERIAL**

Stainless Steel
(A182-F316, A182-F316L, A351-CF8M, A351-CF3M)

■ **END CONNECTION**

Butt weld, Socket weld, Thread, Flange, SUPERLOK Tube Fitting

■ **TEMPERATURE**

Down to -321°F(-196°C)

■ **PRESSURE RATING**

CL150 to CL2,500

Cryogenic Globe Valve

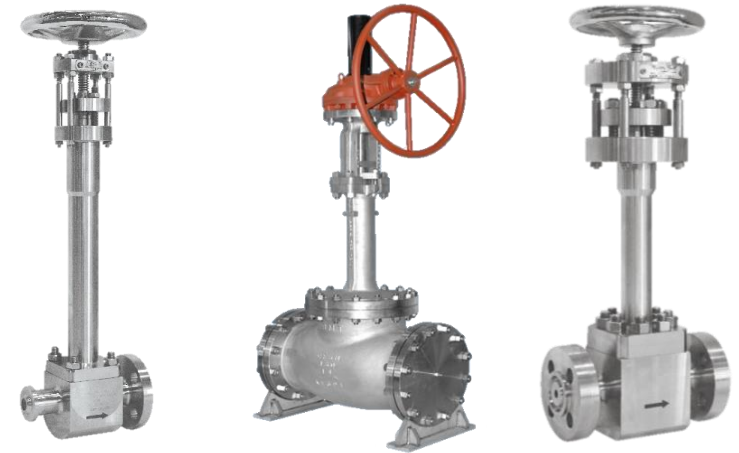

■ **DESIGN SPECIFICATION**

| ASME B16.10, B16.25, B16.5, B16.34
| BS6364

■ **SIZE**

1/2 to 14 in

■ **BODY MATERIAL**

Stainless Steel
(A182-F316, A182-F316L, A351-CF8M, A351-CF3M)

■ **END CONNECTION**

Butt weld, Socket weld, Thread, Flange

■ **TEMPERATURE**

Down to -321°F(-196°C)

■ **PRESSURE RATING**

CL150 to CL2,500

Product Specification

BLOCK & BLEED

CRYOGENIC

BALL & GLOBE

Cryogenic Gate Valve



DESIGN SPECIFICATION

- | ASME B16.10, B16.25, B16.5, B16.34
- | BS6364
- | API 600

■ **SIZE** 2 to 8 in.

BODY MATERIAL

Stainless Steel: A351-CF8M, A351-CF3M

■ **END CONNECTION** Butt weld, Flange

■ **TEMPERATURE** Down to -321°F(-196°C)

■ **PRESSURE RATING** CL150 to CL300

Cryogenic Check Valve

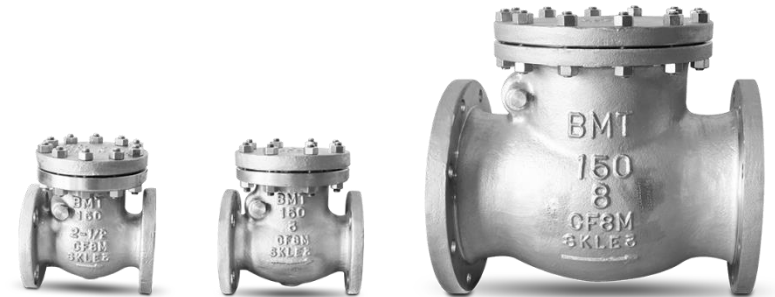

DESIGN SPECIFICATION

- | ASME B16.10, B16.25, B16.5, B16.34
- | BS6364, BS1868

■ **SIZE** 2 to 14 in.

BODY MATERIAL

Stainless Steel: A182-F316, A182-F316L, A351-CF8M, A351-CF3M

■ **END CONNECTION** Butt weld, Flange

■ **TEMPERATURE** Down to -321°F(-196°C)

■ **PRESSURE RATING** CL150 to CL300

Product Specification

BLOCK & BLEED

CRYOGENIC

BALL & GLOBE

Ball Valve



DESIGN SPECIFICATION

- | ASME B16.34, B16.10, B16.5, B16.25, B16.11, B1.20.1
- | API 608, 6D | BS5351
- | (Special) NACE MR-01-75

■ **SIZE** 1/2 to 24 in

BODY MATERIAL

- | Carbon Steel: A105, A350 LF2, A352 LCB/LCC, A216 WCB
- | Stainless Steel: ASTM A182 F316/316L/F51/F53, A351 CF8M/CF3M, A890 4A/6A
- | Duplex: A182 F51/F53
- | Al-bronze Alloy: B148, B150
- | Inconel 625/825

END CONNECTION

Butt Weld, Socket Weld, Thread, Flange

■ **TEMPERATURE** (Soft seated) -49 to 500°F(-45 to 260°C)
(Metal seated) up to 842°F(450°C)

■ **PRESSURE RATING** CL150 to CL2,500

SAE Flanged Ball Valve



DESIGN SPECIFICATION

- | (End Connection) SAE J518 Code 61 & 62
- | (End Connection) ISO 6164-2

■ **SIZE** 1/2 to 5 in

BODY MATERIAL

- | Carbon Steel: A105, A350 LF2
- | Stainless Steel: A182 F316
- | Duplex: A182 F51/F53
- | Al-bronze Alloy: B148, B150
- | Inconel 625/825

END CONNECTION

SAE J518 Code 61&62 Flange, ISO 6164 Flange

■ **TEMPERATURE** -4 to 392°F(-20 ~ 200°C)

■ **PRESSURE RATING** 210 to 420 bar



Piping Valve

Instrument Valve

Fitting

Product Specification

BLOCK & BLEED

CRYOGENIC

BALL & GLOBE

Globe Valve

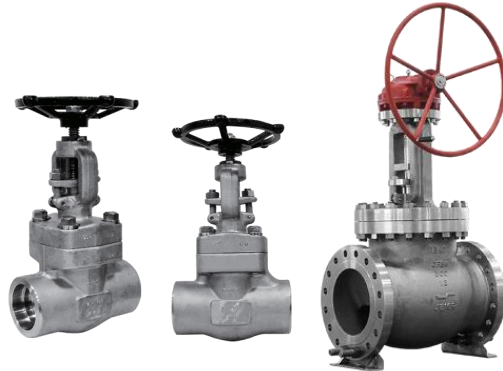

DESIGN SPECIFICATION

ASME B16.10, B16.25, B16.5, B16.34, B1.20.1, B16.11

SIZE 1/2 to 16 in

BODY MATERIAL

I Carbon Steel:	A105, A350 LF2, A216 WCB
I Stainless Steel:	A182 F316, A351 CF8M
I Duplex:	A182 F51/F53
I Al-bronze Alloy:	B148, B150
I Inconel	625/825

CONNECTION

Butt welded, Socket welded, Threaded, Flanged, or Combinations

TEMPERATURE -49 to 842°F (-45 ~ 450°C)

PRESSURE RATING CL150 to CL2,500

OTHER PRODUCT OFFERINGS

Tubing



TYPE

I Seamless Coiled/Straight
I Pre-insulated

SIZE

1/8 to 2 in., 3 to 25 mm



Break Away Coupling

WORKING PRESSURE
Up to 362.5 psi (25 bar)

TEMPERATURE
Down to -321°F (-196°C)

BREAKING FORCE
13KN



Hydraulic Flanges

WORKING PRESSURE
Up to 6000 psi (413 bar)

TEMPERATURE
-20 to 1000°F (-29 to 538°C)

Product Specification

BALL

HIGH PRESSURE

NEEDLE

CHECK

Piping Valve

Instrument Valve

Fitting

SBV 120H Ball Valve



■ **SIZE** 1/16 to 3/4 in, 3 to 12 mm

■ **BODY MATERIAL**

I Stainless Steel: ASTM A479 TP316,
ASTM A276 TP316

I Brass: B16

■ **END CONNECTION**

SUPERLOK Tube Fitting,
Female Thread, Male Thread

■ **TEMPERATURE** 50 to 150°F(10 to 65°C) with PTFE seat and packing

■ **PRESSURE RATING** 3,000 psig (206 bar) @ 100°F(38°C)

SBVH360 Ball Valve



■ **SIZE** 1/4 to 1 in, 6 to 25 mm

■ **BODY MATERIAL**

I Stainless Steel: ASTM A479 TP316,
ASTM A276 TP316

I Brass: ASTM B16

I Alloy 400 (Monel)

■ **END CONNECTION**

SUPERLOK Tube Fitting,
Female Thread, Male Thread

■ **TEMPERATURE** -65 to 302°F(-54 to 150°C) with PCTFE seat
-65 to 500°F(-54 to 260°C)with PEEK seat

■ **PRESSURE RATING** 6,000 psig (413 bar) @ 100°F(38°C)

SBV210 Ball Valve



■ **SIZE** 1/4 to 1 in, 6 to 16 mm

■ **BODY MATERIAL**

I Stainless Steel: ASTM A479 TP316,
ASTM A276 TP316

I Brass: B16

■ **END CONNECTION**

SUPERLOK Tube Fitting,
Female Thread, Male Thread

■ **TEMPERATURE** 0 to 450°F(-17 to 232°C)

■ **PRESSURE RATING** 1,000 psig (69 bar) @ 100°F(38°C)

Key Operation Ball Valve



■ **SIZE** 1/4 to 1 in, 6 to 25 mm

■ **BODY MATERIAL**

Stainless Steel: ASTM A182 F316

■ **END CONNECTION**

SUPERLOK Tube Fitting,
Female Thread, Male Thread

■ **TEMPERATURE** 0 to 450°F (-17 to 232°C) with PTFE seat

■ **PRESSURE RATING** 1000 psi (69 bar) @ 100°F(38°C)

Product Specification

BALL

HIGH PRESSURE

NEEDLE

CHECK

Ball Valve to DIN Standard



- **SIZE** 4mm to 42mm
- **BODY MATERIAL**
 - I Stainless Steel: DIN 17440, ASTM A479 TP316
 - I Carbon Steel: DIN 1651, ASTM A108
- **END CONNECTION**
 - Tube Fitting (DIN 2353),
 - Female BSP Thread, Female NPT Thread

- **TEMPERATURE** -4 to 212°F(-20 to 100°C)
- **PRESSURE RATING** up to 7,200 psig (500 bar) @ 100°F (38°C)

Trunnion Ball Valve



- **SIZE** 1/8 to 1/2 in, 6 to 12 mm
- **BODY MATERIAL**
 - I Stainless Steel: ASTM A479 TP316, ASTM A276 TP316
 - I Alloy 400 (Monel)
- **END CONNECTION**
 - SUPERLOK Tube Fitting,
 - Female Thread, Male Thread

- **TEMPERATURE** 0 to 450°F(-17 to 232°C)
- **PRESSURE RATING** up to 10,000 psig (689 bar) @ 100°F (38°C)

Swing-Out Ball Valve



- **SIZE** 1/4 to 2 in
- **BODY MATERIAL**
 - I Stainless Steel: ASTM A351 CF8M
- **END CONNECTION**
 - SUPERLOK Tube Fitting, Female Thread,
 - Male Thread, Socket Weld, Butt Weld,
 - Sanitary

- **TEMPERATURE** -20 to 450°F(-28 to 232°C)
- **PRESSURE RATING** up to 3,000 psig (206 bar) @ 100°F (38°C)

Forged High Pressure Ball Valve



- **SIZE** 1/8 to 3/4 in, 3 to 16 mm
- **BODY MATERIAL**
 - I Stainless Steel: ASTM A182 F316
 - I Brass: ASTM B283
- **END CONNECTION**
 - SUPERLOK Tube Fitting,
 - Female Thread, Male Thread

- **TEMPERATURE**
 - 65 to 200°F(-54 to 93°C) with PCTFE seat
 - 65 to 350°F(-54 to 177°C) with PTFE seat
- **PRESSURE RATING** up to 6,000 psig (413 bar) @ 100°F (38°C)

Product Specification

BALL

HIGH PRESSURE

NEEDLE

CHECK

High Pressure Needle Valve



- **SIZE** 1/4 to 1 in
- **BODY MATERIAL**
 - | Stainless Steel: ASTM A479 TP316
 - | Hastelloy
 - | Inconel
- **END CONNECTION**
 - | Cone & Threaded connection
- **TEMPERATURE**
 - | 0 to 450°F(-17 to 232°C) with PTFE packing
 - | up to 800°F(427°C) with Graphite packing
- **PRESSURE RATING**
 - | up to 60,000 psig (4,140 bar)

High Pressure Ball Valve



- **SIZE** 1/8 to 1 in
- **BODY MATERIAL**
 - | Stainless Steel: ASTM A479 TP316
 - | Hastelloy
 - | Inconel
- **END CONNECTION**
 - | Cone & Threaded connection
- **TEMPERATURE**
 - | 0 to 400 °F (-17 to 204°C)
- **PRESSURE RATING**
 - | up to 20,000 psig (1,379 bar)

High Pressure Check Valve



- **SIZE** 1/4 to 1 in
- **BODY MATERIAL**
 - | Stainless Steel: ASTM A479 TP316
 - | Hastelloy
 - | Inconel
- **END CONNECTION**
 - | Cone & Threaded connection
- **TEMPERATURE**
 - | -110 to 1,200°F(-79 to 649°C) with Metal seat
 - | -50 to 500°F(-45 to 260°C) with O-ring seat
- **PRESSURE RATING**
 - | up to 60,000 psig (4,140 bar)

Product Specification

BALL

HIGH PRESSURE

NEEDLE

CHECK

Integral Bonnet Needle Valve



- **SIZE** 1/4 to 1/2 in, 3 to 18 mm
- **BODY MATERIAL**
 - | Stainless Steel: ASTM A479 TP316, ASTM A276 TP316
 - | Alloy 400 (Monel)
- **END CONNECTION**
 - | SUPERLOK Tube Fitting, Female Pipe Thread, Male Pipe Thread
- **TEMPERATURE**
 - | -65 to 450°F(-54 to 232°C) with PTFE packing
 - | Up to 1,200°F(649°C) with Graphite packing
- **PRESSURE RATING**
 - | up to 6,000 psig (413 bar) @ 100°F (38°C)

Union Bonnet Needle Valve



- **SIZE** 1/4 to 1 in, 6 to 25 mm
- **BODY MATERIAL**
 - | Stainless Steel: ASTM A479 TP316, ASTM A276 TP316
 - | Alloy 400 (Monel)
 - | Hastelloy
- **END CONNECTION**
 - | SUPERLOK Tube Fitting, Female Pipe Thread, Male Pipe Thread
- **TEMPERATURE**
 - | -65 to 450°F(-54 to 232°C) with PTFE packing
 - | -65 to 600°F(-54 to 315°C) with PEEK packing
 - | up to 1,200°F(649°C) with Graphite packing
- **PRESSURE RATING**
 - | up to 6,000 psig (413 bar) @ 100°F (38°C)

Integral Bonnet Barstock Needle Valve



- **SIZE** 1/4 to 1 in, 6 to 25 mm
- **BODY MATERIAL**
 - | Stainless Steel: ASTM A479 TP316, ASTM A276 TP316
 - | Alloy 400 (Monel)
- **END CONNECTION**
 - | SUPERLOK Tube Fitting, Female Pipe Thread, Male Pipe Thread
- **TEMPERATURE**
 - | -65 to 450°F(-54 to 232°C) with PTFE packing
 - | -65 to 600°F(-54 to 315°C) with PEEK packing
- **PRESSURE RATING**
 - | up to 6,000 psig (413 bar) @ 100°F (38°C)

Product Specification

BALL

HIGH PRESSURE

NEEDLE

CHECK

High Pressure Bar Stock Needle Valve

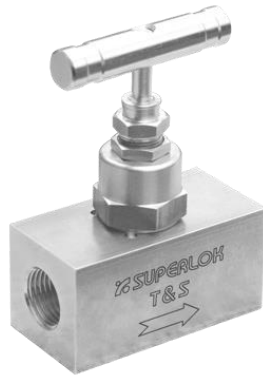

- **SIZE** 1/4 to 1/2 in
- **BODY MATERIAL**
 - I Stainless Steel: ASTM A479 TP316
 - I Carbon Steel: ASTM A105
- **END CONNECTION** Female Pipe Thread, Male Pipe Thread
- **TEMPERATURE** -65 to 450°F(-54 to 232°C) with PTFE packing up to 1,200°F(649°C) with Graphite packing
- **PRESSURE RATING** up to 10,000 psig (689 bar) @ 100°F(38°C)

Instrumentation Manifold Valve



- **SIZE** 1/4 to 1/2 in
- **BODY MATERIAL**
 - I Stainless Steel: ASTM A276 TP316, ASTM A479 TP316
 - I Alloy 400 (Monel)
- **END CONNECTION** Female Pipe Thread, Flange
- **TEMPERATURE** -65 to 450°F(-54 to 232°C) with PTFE packing up to 1,200°F(649°C) with Graphite packing
- **PRESSURE RATING** up to 6,000 psig (413 bar) @ 100°F(38°C)

Instrumentation Gauge Valve

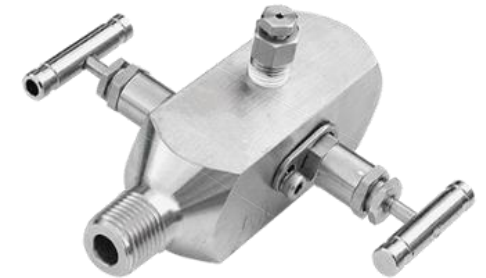

- **SIZE** 1/2 to 3/4 in
- **BODY MATERIAL**
 - I Stainless Steel: ASTM A276 TP316, ASTM A479 TP316
- **END CONNECTION** Female Pipe Thread, Male Pipe Thread
- **TEMPERATURE** -65 to 450°F(-54 to 232°C) with PTFE packing up to 1,200°F(649°C) with Graphite packing
- **PRESSURE RATING** I up to 6,000 psig (413 bar) @ 100°F(38°C)

Product Specification

BALL

HIGH PRESSURE

NEEDLE

CHECK

Check Valve



- **SIZE** 1/8 to 1 in, 6 to 25 mm
- **BODY MATERIAL**
Stainless Steel: ASTM A479 TP316,
ASTM A276 TP316
- **END CONNECTION**
SUPERLOK Tube Fitting,
Female Pipe Thread, Male Pipe Thread
- **TEMPERATURE**
-10 to 375°F(-23~190°C) with VITON
- **PRESSURE RATING**
up to 3,000psig (206 bar) @ 100°F(38°C)
- **CRACKING PRESSURE**
1/3 to 25 psi (0.03 to 1.7 bar) @ 70°F(20°C)

High Pressure Check Valve



- **SIZE** 1/8 to 1 in, 6 to 25 mm
- **BODY MATERIAL**
Stainless Steel: ASTM A479 TP316,
ASTM A276 TP316
- **END CONNECTION**
SUPERLOK Tube Fitting,
Female Pipe Thread, Male Pipe Thread
- **TEMPERATURE**
-10 to 375°F(-23 to 190°C) with VITON
- **PRESSURE RATING**
up to 6,000 psig (413 bar) @ 100°F(38°C)
- **CRACKING PRESSURE**
1/3 to 25 psi (0.03 to 1.7 bar) @ 70°F(20°C)

One-Piece Check Valve



- **SIZE** 1/4 to 3/4 in
- **BODY MATERIAL**
I Stainless Steel: ASTM A276 TP316
I Brass: ASTM B16
- **END CONNECTION**
Female Pipe Thread, Male Pipe Thread
- **TEMPERATURE**
-10 to 375°F(-23 to 190°C) with VITON
- **PRESSURE RATING**
up to 3,000psig (206 bar) @ 100°F(38°C)
- **CRACKING PRESSURE**
1/3 to 25 psi (0.03 to 1.7 bar) @ 70°F(20°C)

Product Specification

BALL

HIGH PRESSURE

NEEDLE

CHECK

One-piece Adjustable Check Valve



- **SIZE** 1/4 to 1/2 in
- **BODY MATERIAL**
Stainless Steel: ASTM A479 TP316,
ASTM A276 TP316
Brass: ASTM B16
- **END CONNECTION**
Female Pipe Thread, Male Pipe Thread
- **TEMPERATURE**
-10 to 375 °F (-23~190 °C) with VITON
- **PRESSURE RATING**
up to 3,000 psig (206 bar) @ 100 °F (38 °C)
- **CRACKING PRESSURE**
3 to 600 psi (0.2 to 41.3 bar) @ 70 °F (20 °C)

Adjustable Check Valve



- **SIZE** 1/4 to 3/8 in., 6 to 8 mm
- **BODY MATERIAL**
Stainless Steel: ASTM A479 TP316,
ASTM A276 TP316
Brass: ASTM B16
- **END CONNECTION**
SUPERLOK Tube Fitting, Male Pipe Thread
- **TEMPERATURE**
-10 to 375 °F (-23 to 190 °C) with VITON
- **PRESSURE RATING**
up to 3,000 psig (206 bar) @ 100°F (38°C)
- **CRACKING PRESSURE**
3 to 600 psi (0.2 to 41.3 bar) @ 70°F(20°C)

Industrial Excess Flow Valve



- **SIZE** 1/8 ~ 1/2 in, 6 ~ 12 mm
- **BODY MATERIAL**
Stainless Steel: ASTM A479 TP316,
ASTM A276 TP316
- **END CONNECTION**
SUPERLOK Tube Fitting,
Female Pipe Thread, Male Pipe Thread
- **TEMPERATURE**
-10 to 400 °F (-23 to 204 °C) with VITON
- **PRESSURE RATING**
up to 6,000 psig (413 bar) @ 100°F(38°C)

Product Specification

Instrument Valve Piping Valve

Fitting

SUPERLOK Tube Fitting (Compression Type)

■ **SIZE**

1/16 to 2 in, 2 to 38 mm

■ **PRESSURE RATING**

Limited by the working pressure of the tube

■ **TEMPERATURE**

-320 to 1,200°F (-196 to 649°C)

■ **BODY MATERIAL**

I Stainless Steel: ASTM A479 TP316,
ASTM A276 TP316,
ASTM A182 F316

I Brass: ASTM B16, ASTM B453, ASTM B283

I Carbon Steel: ASTM A105

I Monel, Alloy 400

I Inconel, Alloy 600

I Hastelloy, Alloy C-276



Bite Type Tube Fitting (DIN2353)

■ **SIZE**

4mm to 42 mm

■ **PRESSURE RATING**

Very Light Series: PN 100 bar

Light Series: PN 315 bar

Heavy Series: PN 630 bar

■ **TEMPERATURE**

-76 to 752°F (-60 to 400°C)

■ **BODY MATERIAL**

I Stainless Steel: DIN 17440, ASTM A479 TP316,
ASTM A276 TP316

I Brass: DIN 17660, DIN 17672, ASTM B16

I Carbon Steel: DIN 3859, ASTM A108



Bite Type Tube Fitting (JIS B2351)

■ **SIZE**

1/8 to 1-1/2 in, 4 to 50 mm

■ **PRESSURE RATING**

7,250 psi (500 bar)

■ **TEMPERATURE**

-76 to 752°F (-60 to 400°C)

■ **BODY MATERIAL**

I Stainless Steel: SUS316

I Brass: JIS H3250, C3604, C3771

I Carbon Steel: JIS G4051, S10C, S10C-S48C, S20C-S48C



High Pressure Fittings

■ **SIZE**

1/4 to 1 in

■ **PRESSURE RATING**

60,000 psi (4,137 bar)

■ **TEMPERATURE**

-423 to 1,200°F (-252 to 649°C)

■ **BODY MATERIAL**

Stainless Steel: ASTM A479 TP316



Product Specification

37° Flared Tube Fitting (STD: SAE J514)

■ SIZE

1/8 to 2 in, 2 to 50 mm

■ PRESSURE RATING

8,700 psi (600 bar) @ 100°F(38°C) with O-Ring
5,000 psi (345 bar) @ 100°F(38°C) without O-Ring

■ TEMPERATURE

800°F(427°C)

■ BODY MATERIAL

I Stainless Steel: ASTM A479 TP316, ASTM A276 TP316, ASTM A182 F316
I Brass: ASTM B16, ASTM B453, ASTM B283
I Carbon Steel: ASTM A105



Instrument Thread Fitting (STD: ASME B1.20.1, SAE AS71051, ISO 228/1, JIS B0202, ISO 7/1, JIS B0203)

■ SIZE

1/8 to 1 in

■ PRESSURE RATING

10,000 psi (689 bar) @ 100°F(38°C)

■ TEMPERATURE

-320 to 1,000°F(-196 to 537°C)

■ BODY MATERIAL

I Stainless Steel: ASTM A479 TP316, ASTM A276 TP316, ASTM A182 F316
I Brass: ASTM B16, ASTM B453, ASTM B283
I Carbon Steel: ASTM A108, ASTM A105



O-ring Face Seal Fitting (O-ring Face to Face)

■ SIZE

1/8 to 1 in

■ PRESSURE RATING

In accordance with ASME Code for Pressure Piping B31.3 (Process Piping) and ASME B31.1 (Power Piping)

■ TEMPERATURE

determined by the O-ring materials.

■ BODY MATERIAL

Stainless Steel: ASTM A479 TP316, ASTM A276 TP316, ASTM, A182 F316



Pipe (Forged) Fittings

■ SIZE

1/2 to 4 in.

■ PRESSURE RATING

3000 lbs, 6000 lbs, 9000 lbs

■ BODY MATERIAL

I Stainless Steel: ASTM A182 304/F316/F51/F53/F55 /F5/F9/F11/F12/F22/F91
I Carbon Steel: ASTM A105, A350 LF2
I Monel, Inconel



Product Specification



PERFECT CONNECTION can be **SEEN, HEARD, FELT** with the **SAFEST** fitting in the market!!

i-Fitting® ensure a safe, quick, and precise connection every time. The “**Check Ring**”, which functions as a built-in gap gauge, separates as a fitting is tightened to the exact point of perfect compression.

This quality control and safety features indicate that a fitting has been tightened properly and is not easily confused with other fittings on a job that have not been tightened.

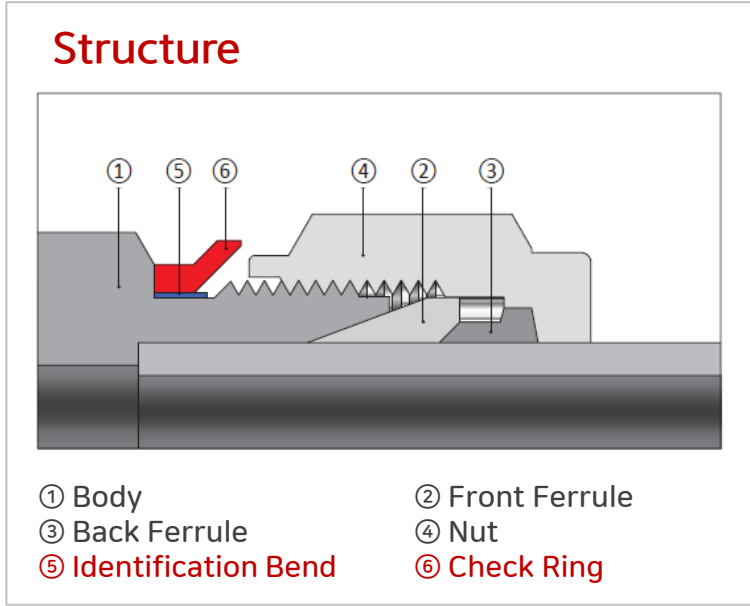

↓ Scan for Video

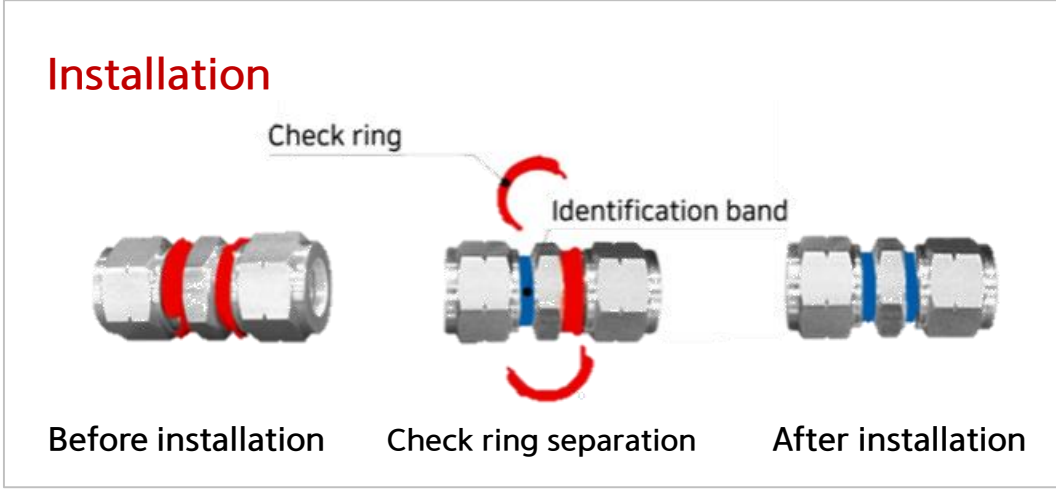

Product Specification



Innovative **BMT's patent fitting** registered with **Chevron & LG Display**

Can you See the Potential Leak Points?

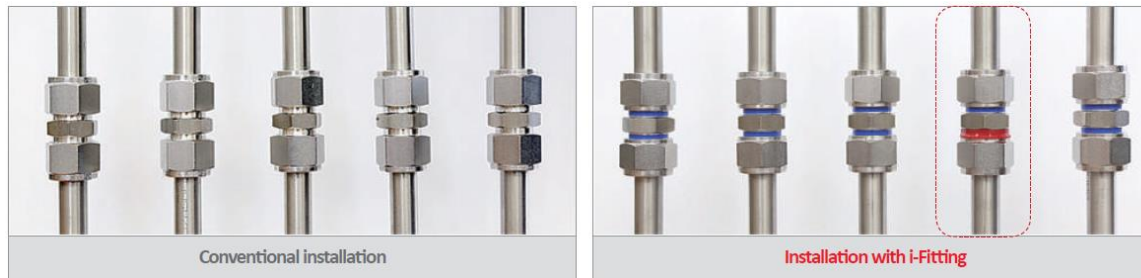

i-Fitting enables efficient and safe installation by helping installers identify the status of installation simply by 'seeing, hearing, and touching'. Upon completion of installation, additional inspection with separate tools such as gap-inspection gauge (which normally required for conventional tube fitting) is not required. i-Fitting, therefore, not only saves installation time but also minimizes overall quality costs by reducing errors.

Specifications

- **SIZE**
1/4 to 1 in, 6 to 25 mm
- **PRESSURE RATING**
Limited by the working pressure of the tube
- **TEMPERATURE**
-320 to 1,200 °F (-196 to 649 °C)

- **BODY MATERIAL**
 | Stainless Steel: ASTM A479 TP316, ASTM A276 TP316, ASTM A182 F316
 | Brass: ASTM B16, ASTM B453, ASTM B283
 | Carbon Steel: ASTM A105
 | Monel, Alloy 400

Energy Technology Company
1400 Smith Street,
Houston, TX
USA

January 15, 2018

Mr. J.C. Yoon, President
BMT Co., LTD
35, Saemal-gongdanmum 11-gil, Yangsan-si
Gyeongsangnam-do, South Korea

ATTENTION: Mr. J.C. Yoon - President

SUBJECT: APPROVED MANUFACTURER NOTICE

The purpose of this letter is to reaffirm to you that BMT, Co., LTD has satisfied the requirements of Chevron's Vendor Approval Program. This approved status will remain in effect until January 2021 at which time Chevron plans to again review the performance of your products. During this time Chevron may conduct random inspections of your facilities and/or products as deemed necessary.

Listed below are the approved locations and product lines for the Chevron Recommended Manufacturer Lists.

Material	Product Range					Instrumentation Valves (Incl. manifold)
	Ball	DBB	Cryogenic	Tube fitting	i-Fitting*	
Carbon Steel	Size: 1/2" to 24" Rating: up to CL 2,500	Size: 1/2" to 24" Rating: up to CL 2,500		Size: 1/16" ~ 1" Rating: Up to 10,000 psig	Size: 1/4" ~ 1" Rating: Up to 10,000 psig	Size: Up to 2" Rating: Up to 10,000 psig
Austenitic	Size: 1/2" to 24" Rating: up to CL 2,500	Size: 1/2" to 24" Rating: up to CL 2,500	Size: 1/2" to 14" Rating: up to CL 2,500	Size: 1/16" ~ 1" Rating: Up to 10,000 psig	Size: 1/4" ~ 1" Rating: Up to 10,000 psig	Size: Up to 2" Rating: Up to 10,000 psig
Bronze & Brass Al Bronze				Size: 1/8" ~ 1" Rating: Up to 3,500 psig	Size: 1/4" ~ 1" Rating: Up to 3,500 psig	Size: Up to 1" Rating: Up to 3,000 psig
Duplex / Super Duplex	Size: 1/2" to 24" Rating: up to CL 2,500	Size: 1/2" to 24" Rating: up to CL 2,500		Size: 1/16" ~ 1" Rating: Up to 10,000 psig	Size: 1/4" ~ 1" Rating: Up to 10,000 psig	Size: Up to 2" Rating: Up to 10,000 psig
Nickel Alloy (High Alloys)	Size: 1/2" to 24" Rating: up to CL 2,500	Size: 1/2" to 24" Rating: up to CL 2,500		Size: 1/16" ~ 1" Rating: Up to 10,000 psig	Size: 1/4" ~ 1" Rating: Up to 10,000 psig	Size: Up to 2" Rating: Up to 10,000 psig

Chevron Vendor Approval Letter

Product Specification

Pre-Forming Fitting

Double Ferrule Tube Fittings for Medium Pressure & Special Materials

Pre-forming Fitting features double ferrule compression system that provides leak-tight sealing for medium-pressure rated up to 15,000 psig (1,034 bar) with different special tubing materials. Pre-forming fitting is most efficient solution for industrial sites where safety is the highest priority.



↓ Scan for Video



Pre-Forming Fitting

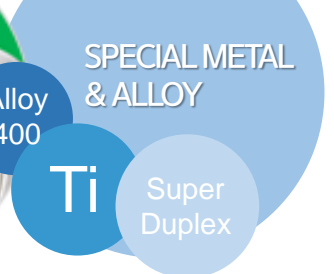
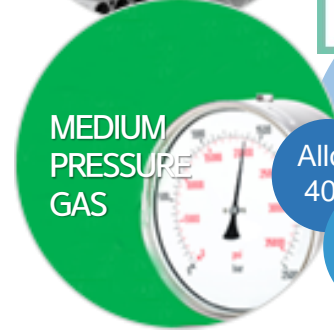

Specifications

- **SIZE**
1/4 in. to 1 in., 6mm to 25mm
- **PRESSURE RATING**
up to 15,000 psig (1,034 bar)
- **TEMPERATURE**
-423 to 1200°F (-252 to 649°C)
- **BODY MATERIAL**
Titanium, Super Duplex, Alloy C-276, Alloy 400, Alloy 20, 316 Stainless Steel
- **END CONNECTION**
Female Thread, Male Thread



Patent (Korea) #10-1530670

Production Facilities & Capacities

2023.07
Grand Open

HQ/Plant 1



- Administration
- R&D Center
- Production of Instru. Fittings & Valve

35
Sanmakgongdannam11-gil
Yangsan-si
Gyeongsangnam-do
50568 South Korea

Floor Area : 205,795 ft²
(19,119 m²)
Plot Area: 194,880 ft²
(18,105 m²)

Plant 2



- Production of Process / Cryogenic Valves
- Production of UHP Products

29
Sanmakgongdannam8-gil
Yangsan-si
Gyeongsangnam-do
50568 South Korea

Floor Area : 88,888 ft²
(8,258 m²)
Plot Area: 125,270 ft²
(11,638 m²)



17, Sinsojaesandan 2-ro, Jangan-eup,
Gijang-gun, Busan, 46031 South Korea

Floor Area: 477,379 ft²
(44,350 m²)

Plot Area: 741,633 ft²
(68,900 m²)



*This address is effective form July.

Production Facilities & Capacities

Annual Capacity

Fittings 10,000,000 ea	Instrument Valves 900,000 ea
Manifold Valves 50,000 ea	Ball/DBB Valves 7,000 ea
Cryogenic Valves 5,000 ea	

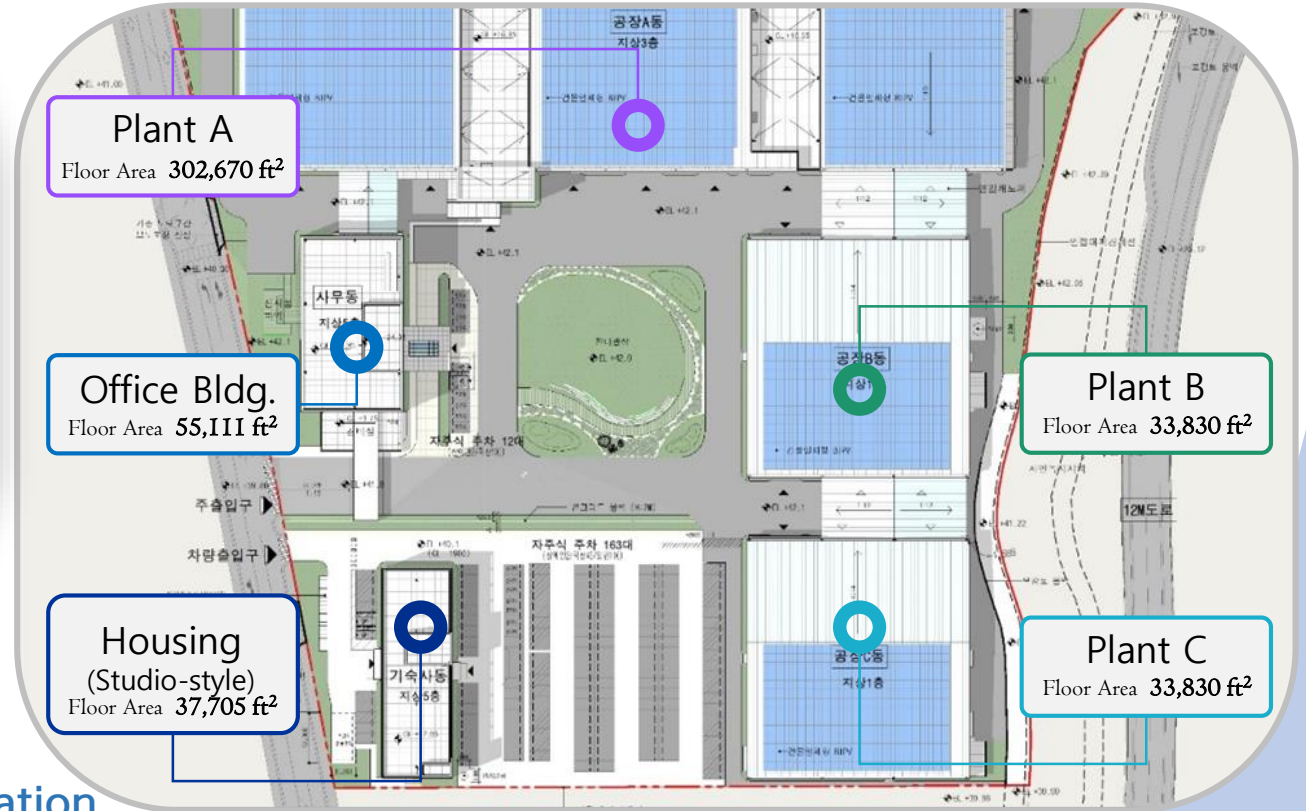

Production Capacity after Relocation



Fittings
20,000,000
ea



Instrument Valves
2,000,000
ea



Manifold Valves
50,000
ea



Ball/DBB Valves
30,000
ea



Cryogenic Valves
10,000
ea

Production Equipment

Machining

Description	Q' ty
Cutting/Milling/Drilling Machine	6
CNC Lathe	187
Machining Center	40
Thread Rolling Machine	5



Cleaning & Assembly

Description	Q' ty
Cleaning/Passivation Machine	4
Auto Fitting Ass'y Machine	18
Auto Valve Ass'y Machine	4



Marking & Packaging

Description	Q' ty
Marking Machine	5
Auto Box Bending / Packaging Machine	3



Painting

Description	Q' ty
Shot Blasting Machine / Paint Booth / Drying Oven	1 set

Test/Inspection Equipment

Verification of Raw Material



Vickers Hardness Tester



Rockwell Hardness Tester



Spectrometer



PMI (2 ea)



Universal Test Machine

Verification of Machined Parts



Profile Projector



Form Tester



Surface Roughness Measuring Instrument



Contact Coordinate Measuring Machine



Ferrule Tester (3ea)



Temp & Humid Controller

Test/Inspection Equipment

Verification of Instrument Fittings



Impulse & Vibration Tester



Rotary Flex Tester (with Strain Gauge)



High Pressure Gas Tester (N2)



Pressure Test Unit (Water)

Verification of Instrument Valves



N2 Leak Tester (6ea)



Cracking Tester



High Pressure Gas Tester (Water)

Test/Inspection Equipment

Verification of Process Valves



Hydraulic Valve Pressure Tester (4ea)



Cryogenic Valve Tester
(2 Boosters and 9 Chambers)



Hydraulic & Pneumatic Valve Pressure Tester (4ea)



Fire Safety Tester



Dew Point Meter



Chloride Tester



Surface Adhesion Tester

R&D Capabilities

Introduction to BMT R&D Center

KOITA Registered
 (Korea Industrial Technology Association)
Business Affiliated Research Institute

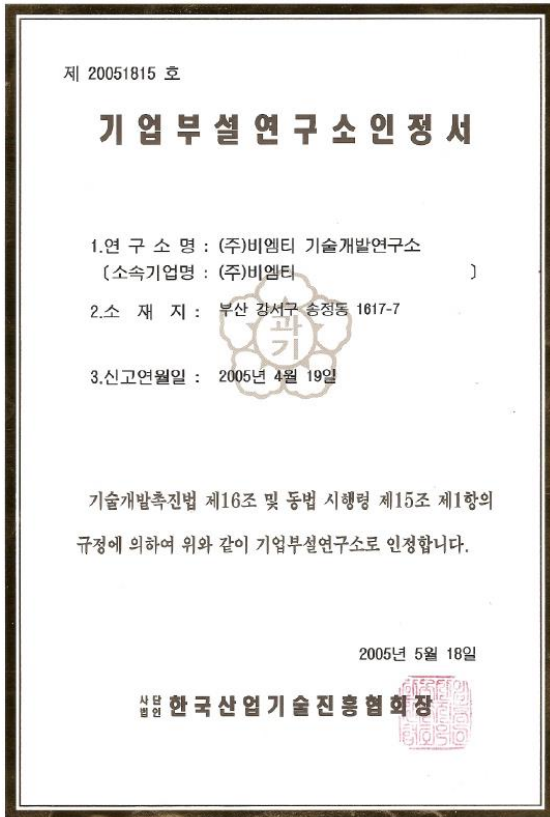

- Registration Number: 20051815
- Registered Date: 2005-04-19

Organizations & Research Areas

BMT R&D Center is the source of power for BMT's future. With continued product expansion and business diversification, BMT R&D Center has been reinforcing its internal capabilities and continuously create customer values across various sectors.



www.superlok.com

Fittings & Valves

Instrumentation

5

Process Piping

9

Ultra High Purity

9

Manpower



www.bmtelectric.com

Electric & Energy

Electrical Enclosures

6

Energy Solution

5



www.powercoolair.com

HVAC

Air-conditioner

1

R&D Capabilities

R&D Investment & Intellectual Properties

Continuous Investment

R&D Intensity (R&D-to-Sales Ratio)

R&D-to-Sales (Total Fund) : approx. **6.5%**

* Total Funds = Funding from BMT's own funds and Korean Government

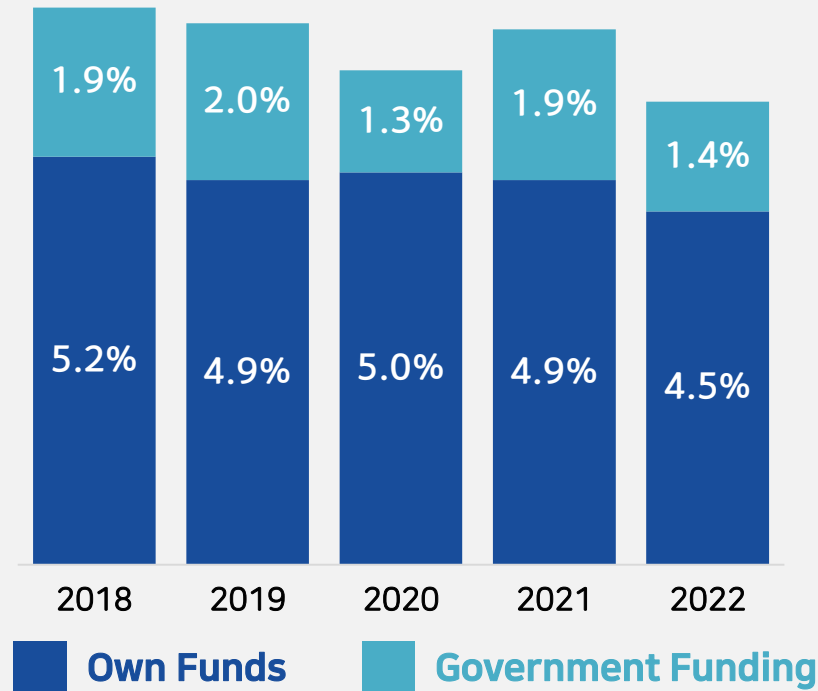

Intellectual Properties

65 Patents



85

Intellectual Properties

(Registered and Valid Only)



8 Trademarks



12 Designs

Certifications



ISO9001
Quality Management System



ISO14001
Environment Management System



ISO45001
OHS Management System



API-6D
Ball Valves



PED
Valves and Fittings



ASME N/NPT
Valves, Supports, etc. (Class 1, 2, 3)



KEPIC-MN
Valves, Fittings, etc. (Class 1, 2, 3)



Compliance Certificate to EC(79.2009) & ECE(R110)
Tube Fittings, Instrument Valves, Filters and Receptacles

Certifications



DNV Type Approvals
Tube Fittings,
Cryogenic Valves



LR Type Approvals
Tube Fittings,
Cryogenic Valves,
Ball Valves



BV Type Approvals
Tube Fittings,
Cryogenic Valves



ABS Type Approvals
Tube Fittings,
Cryogenic Valves

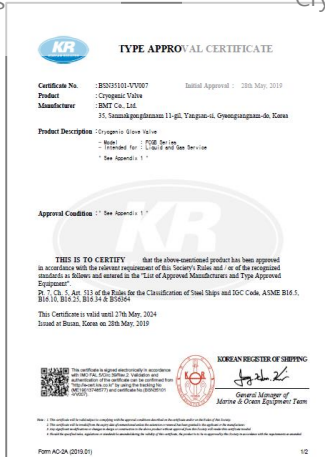

KR Type Approvals
Cryogenic Valves



NK Type Approvals
Tube Fittings

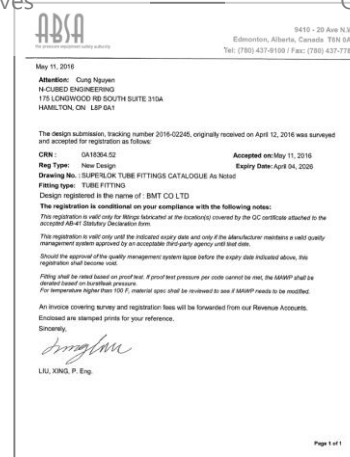

ABSA Design Registration
(CRN: Canadian Registration #)
Tube Fittings, Instrument Valves,
Block & Bleed Valves, etc.









Vendor Registration

Company Name	Date	Nationality	Registered Items
 Saudi Aramco <small>أرامكو السعودية saudi aramco</small>	07-Mar-2022	Saudi Arabia	1. Fitting; 2. Ball Valve (Size up to 2 in.); 3. Instrument Valve; 4. Manifold Valves
 Nawah Energy <small>شركة نواة للطاقة Nawah Energy Company</small>	31-Mar-2022	UAE	1. Construction of Class 1, 2, 3 line Valve (for instrument); 2. Class 1, 2, 3, MC, CS fabrication for parts & appurtenance and Class 2, 3 fabrication for piping subassembly; 3. Manufacturing fitting & flange and supplying ferrous, nonferrous and welding material
 PETROBRAS <small>PETROBRAS</small>	16-Mar-2021	Brazil	1. Instrument Needle Valves; 2. Instrument Ball Valves; 3. Instrument Check valves; 4. Compression Tube Fittings; 5. Double Ferrule Fittings; 6. Hydraulic Valves; 7. Single Ferrule Fittings
 QP <small>قطر للبترول Qatar Petroleum</small> (Qatar Petroleum)	18-Jan-2021	Qatar	1. Instrument Valves; 2. Manifolds; 3. Integral Block-and-Bleed Valves; 4. Monoflange for fittings
 ORPIC <small>أورب Orpic</small> (Oman Refinery Company)	17-Feb-2019	Oman	1. DBB Valves; 2. Instrument Fittings/Valves
 PDO <small>شركة تنمية نفط عمان Petroleum Development Oman</small> (Petroleum Development Oman)	27-Sep-2018	Oman	1. Super Pressure Fittings (>10,000 PSI); 2. Tubing Orifice Fitting; 3. Tubing Mounting Brackets; 4. Condensate Pot/Seal Pot; 5. Gauge Adaptors 1/2" NPT -Male to Female; 6. Gauge Adaptors 1/2" NPT -Male to Male; 7. Instrument Installation Materials; 8. Quick Exhaust Valve Contr. Valve/Choke; 9. Metering Valves; 10. Valve-Needle; 11. Valves-Ball; 12. Valves-Check; 13. Instrument Valves-Gauge/Root; 14. Manifold-Installation Materials; 15. Instrument Tubing (Seamless/Seamwelded)
 SABIC (Saudi Basic Industries Corporation)	8-Apr-2018	Saudi Arabia	1. Instrumentation Fittings & Valves
 Chevron	15-Jan-2018	USA	1. Ball Valves (up to 24", up to CL 2500); 2. DBB Valves (up to 24", up to CL2500); 3. Cryogenic Valves (up to 14", up to CL 2500); 4. Tube Fittings (up to 2", up to 10000 psig); 5. i-Fittings (up to 1", up to 10000 psig); 6. Instrumentation Valves including manifold (up to 2", up to 10000 psig)

* This list is sorted by initial registration date.

** Affiliate subsidiary companies of ADNOC (Abi Dhabi National Oil Company) Group. BMT is a registered supplier of ADNOC Group.







Vendor Registration

Company Name	Date	Nationality	Registered Items
 TAKREER** (Abu Dhabi Oil Refining Company)	29-Dec-2016	UAE	1. Valves: Ball (Approved Only For Size Range 1/2" To 4"); 2. Valves: Double Block (Approved Only For Size Range 1/2" To 4"); 3. Fittings: Compression; 4. Fittings: CS/AS/SS (Buttweld); 5. Instrument Valves And Manifolds
 ZADCO** (Zakum Development Company)	15-Dec-2016	UAE	1. Fittings - for Tubes (Compression Type); 2. Valves - Double Block and Bleed; 3. Instrument Tubing; 4. Compression Fittings for Instrument Tubing; 5. Valve manifolds -for Instruments
 Petronas Carigali	14-Apr-2016	Malaysia	1. Instrument Tube; 2. Instrument Fitting; 3. Instrument Valves & Manifolds; 4. DBB Valves (Non-Instrument)
 ExxonMobil	11-Dec-2015	USA	1. Ball Valve, API 6D, Trunnion Mounted, Soft-Sealed Classes 150, 300 and 600 (up to 10 inch diameter) Fire-safe to API607 - Piping AML Category 7.7; 2. Ball Valve, API 6D, Floating Ball, Flanged, Soft-Sealed, Classes 150 and 300 Up to NPS 6 (full bore, class 150), up to NPS 4 (full bore, Class 300), Fire-safe to API 607
 ADMA-OPCO** (Abu Dhabi Marine Operating Company)	29-Sep-2015	UAE	1. DBB Valves; 2. Tube Fittings (Compression Type); 3. Instrument Tubing; 4. Compression Fittings/Adapter Flange for Instrument Tubing; 5. Valve Manifolds for Instruments
 BOROUGE** (Abu Dhabi Polymers Co., Ltd.)	19-May-2015	UAE	1. High Pressure Components; 2. Manifold & Parts; 3. General Instruments; 4. Flanged Ball Valve ANSI/MMS/API/BS; 5. Tubing Needle Valve; 6. House Connectors & Accessories; 7. Quick Connector-Tubing; 8. Fitting Connectors DIN
 ADCO** (Abu Dhabi Company for Onshore Petroleum Operations Ltd.)	1-Apr-2015	UAE	1. Fittings - For Tubes (Compression Type); 2. Fittings - For Pipes - CS/AS/SS - BW; 3. Instrument Tubing; 4. Valve Manifolds - For Instruments
 GAZPROM	17-Mar-2015	Russia	1. Instrument Fittings & Valves

* This list is sorted by initial registration date.

** Affiliate subsidiary companies of ADNOC (Abi Dhabi National Oil Company) Group. BMT is a registered supplier of ADNOC Group.

Vendor Registration

Company Name	Date	Nationality	Registered Items
 ADGAS** (Abu Dhabi Gas Liquefaction Company Ltd.)	20-Jul-2014	UAE	1. Fittings - For Tubes (Compression Type); 2. Valve Manifolds - For Instruments; 3. Valves - Double Block & Bleed; 4. Valves : Ball (Standard Side Entry Valve For Process Plants); 5. General Use/Bulk Materials & Requisites - For Instrument Workshop; 6. Lighting Distribution Boards For Safe Areas
 KNPC (Kuwait National Petroleum Company)	20-Apr-2014	Kuwait	1. Fittings Pipe Below 2 inches - C.Steel; 2. Fittings Pipe below 2 inches - S.Steel; 3. Fittings Pipe below 2 inches - Alloy Steel; 4. Valves, Ball; 5. Quick Shut-Off, Ball Valves; 6. Barstock Needle Valves including angle & manifolds; 7. Manifolds / Tube Fittings and accessories; 8. Pipe Fittings - C.Steel - below 1/2"; 9. Pipe Fittings - S.Steel - below 1/2"; 10. Pipe Fittings - Alloy Steel - below 1/2"
 FERTIL** (Ruweis Fertilizer Industries)	5-Mar-2014	UAE	1. Fittings : Compression; 2. Fittings : CS/AS/SS (FORGED/SOCKED WELD/THREAD); 3. Instrument Fittings; 4. Instrument Valves and Manifolds; 5. LV Distribution Board & Lighting Panels for safe area; 6. PTFE lined Ball Valves; 7. Valves : Ball; 8. Valves : Double Block
 Petroamazonas EP	13-Feb-2014	Ecuador	1. Instrument Fittings and Valves (Stainless Steel)
 PERTAMINA	15-Feb-2012	Indonesia	1. SUPERLOK Fittings & Valves
 Mitsubishi Heavy Industry - Hiroshima Machinery Works	11-Jul-2011	Japan	1. Instrument Fittings & Valves
 KOC (Kuwait Oil Company)	21-Oct-2008	Kuwait	1. Impulse Pipe Fittings; 2. Instrument Valves

* This list is sorted by initial registration date.

** Affiliate subsidiary companies of ADNOC (Abi Dhabi National Oil Company) Group. BMT is a registered supplier of ADNOC Group.

PROJECT	LOCATION	OWNER	CLIENT	YEAR	ITEM
Global Meridian Holdings 174K LNGC CRYO STAR ECOCHILL	UAE	ADNOC	Jiangnan Shipyard Young Kwang	2023	Cryogenic Ball Valves, Cryogenic Needle Valves, Cryogenic Life Check Valves
Global Meridian Holdings 174K LNGC CRYO STAR ECOCHILL	Bermuda	Global Meridian Holdings Ltd.	Samsung Heavy Industries	2023	Cryogenic Ball Valves, Cryogenic Needle Valves, Cryogenic Life Check Valves
Navios Maritimes Partners L.P. 7700TEU Container LNG DF	Greece	Navios Maritimes Partners L.P.	KSOE	2023	Cryogenic Butterfly & Globe Valves, Cryogenic Remote Butterfly Valves, Cryogenic Remote Globe Valves, Cryogenic SDNR & Control Globe Valves
Ray Shipping 7400 PCTC LNG DF FGSS	Israel	Ray Shipping	KSOE	2023	Cryogenic Swing Check & Globe Valves, Cryogenic Needle & SDNR Valves, Cryogenic Remote Globe Valves
MSC 7900TEU Container LNG DF FGSS	Switzerland	Mediterranean Shipping	KSOE	2023	Cryogenic Swing Check & Globe Valves, Cryogenic Needle & SDNR Valves, Cryogenic Remote Globe Valves
Samsung AMMONIA PILOT TEST FACILITY	Korea	Samsung Heavy Industries	PANASIA	2023	Ammonia(NH3) Ball & Needle Valves, Ammonia(NH3) Globe & Gate Valves, Ammonia(NH3) DBB Valves, Ammonia(NH3) Butterfly Valves, Ammonia(NH3) Swing Check Valves
SK shipping 174K CBM LNG Carrier	Korea	SK Shipping	Hyundai Heavy Industries	2023	Cryogenic Ball Valves
SK shipping 174K CBM LNG Carrier	Korea	SK Shipping	Hyundai Heavy Industries	2023	Cryogenic Needle Valves

Reference_ Offshore & Shipbuilding

Offshore & Shipbuilding

PROJECT	LOCATION	OWNER	CLIENT	YEAR	ITEM
CMA CGM 2000TEU LNG Dual Fuel Container FGSS	France	CMA CGM	KSOE	2023	Cryogenic Butterfly Valves, Cryogenic Ball Valves, Cryogenic Globe Valves, Cryogenic SDNR Valves, Cryogenic Swing Check Valves
AP Moller-Maersk Line A/S 16,200TEU MeOH Dual Fuel Container : Hyundai integrated Gas Supply system	Denmark	Maersk Line	Hyundai Heavy Industries	2023	Methanol(MeOH) Remote Ball Valves, Methanol(MeOH) Ball & Butterfly Valves, Methanol(MeOH) Remote Globe Valves, Methanol(MeOH) Globe & SDNR Valves, Methanol(MeOH) Swing Check Valves, Methanol(MeOH) Strainer, Sight Glass, Tubings
Dynagas 200K LNGC Cargo System	Greece	Dynagas Ltd.	Hyundai Heavy Industries	2023	Cryogenic Ball Valves
174K CBM LNG Carrier	Korea	Hyundai LNG Shipping	DSME	2022	Cryogenic Globe/Gate/Check Valves, Cryogenic Ball Valves, Cryogenic Remote Globe Valves
15,000TEU CONTAINER SHIP LNG DF FGSS	Various	Seaspan	Samsung Heavy Industries (TKT)	2022	Cryogenic Globe/Check Valves, Cryogenic Ball Valves, Cryogenic Needle Valves, Cryogenic SDNR
300K VLCC LNG DF LNG TANK	Various	Maran tankers	Samsung Heavy Industries (WE)	2022	Cryogenic Ball Valves, Cryogenic Check Valve, Cryogenic Needle Valves
300K VLCC LNG DF FGSS	Various	Maran tankers	Samsung Heavy Industries (TKT)	2022	Cryogenic Globe/Check Valves, Cryogenic Ball Valves, Cryogenic Needle Valves,
174K LNGC Cargo System	Norway	Knusten OAS Shipping	Hyundai Samho	2022	Cryogenic Ball/Needle Valves
200K LNGC Cargo System	Norway	Dynagas LTD	Hyundai Heavy Industries	2022	Cryogenic Ball Valves

Reference_ Offshore & Shipbuilding

Offshore & Shipbuilding

PROJECT	LOCATION	OWNER	CLIENT	YEAR	ITEM
86K LPG LFSS LFSS SYS. & LPG Tank	Korea	Hyundai LNG Shipping	Hyundai Samho	2022	Cryogenic Ball Valves, Cryogenic Remote Ball Valves, Cryogenic Globe/Check Valves
91K LPG LFSS LFSS SYS. & LPG Tank	Greece	Evalend Shipping	Hyundai Samho	2022	Cryogenic Ball & Remote Ball Valves, Cryogenic Globe & Check Valves
23,660TEU CONTAINER SHIP (LFS)	Germany	Hapag Lloyd	DSME	2021	Cryogenic Globe & Remote Globe Valves, Cryogenic Gate & Check Valves
23,660TEU CONTAINER SHIP (LFS) BOG Heate	Germany	Hapag Lloyd	DSME (Dong Hwa Entec)	2021	Cryogenic Ball / Needle Valves
7.5K LNG Bunkering Vessel	Korea	KOGAS	Hyundai Heavy Industries	2021	Cryogenic Globe & Remote Globe Valves, Cryogenic Check Valves, Cryogenic SDNR
P6747 LNG DF	Singapore	Lita Ocean	VALMAX	2021	Cryogenic Ball / Needle Valves
2-2 TEST FACILITY - HP VAPORIZER SKID	Korea	Hyundai Mipo	DongHwa Entec	2021	Cryogenic Globe / Needle Valves, Cryogenic SDNR
Senegal FPSO	Singapore	Woodside	MODEC	2021	DBB Valves
Sovcomflot 114K COT LNG	Various	SOVCOMFLOT	HSHI (SUNBO Industries)	2020	Ball Valves, Cryogenic Ball &Globe Valves, Cryogenic Needle Valves, Cryogenic Screw Down None Return Gate / Globe / Swing Check Valves, Instrument Two Piece Ball Valves
K-LINE 80K LNG CARRIER	Various	K-LINE (Kawasaki Kisen Kaisha, Ltd.)	Hudong-Zhonghua Shipbuilding (DongHwa Entec)	2020	Cryogenic Needle Valves
25K PC Tanker FGSS & Bunkering Station	Various	JP Morgan	HHI(SUNBO Industries)	2020	Cryogenic SDNR/ Globe/ Needle Valves
20,000 DWT Class Roll-on / Roll-off Carrier	Various	CLdN	HHI	2020	2-piece Ball Valves

Reference_ Offshore & Shipbuilding

PROJECT	LOCATION	OWNER	CLIENT	YEAR	ITEM
25K PC Tanker Bunkering Station& LNG TANK	Various	JP Morgan	HHI	2020	Top Entry Cryogenic Ball Valves, Cryogenic Butterfly & Globe Valves, Cryogenic Lift Check Valve, Cryogenic Remote Globe & Butterfly Valves
SINOKOR 300K VLCC LNG TANK	Various	Sinokor Merchant Marine	SHI	2020	Top Entry Cryogenic Ball Valves
Reliance KGD6 RUBY FPSO	Various	Reliance Industries	SHI	2020	Non-cryogenic Needle Valves
BP MAD DOG2 FPU	Various	BP	SHI	2020	2-piece Ball Valves
14800 CNTR(DF)	Various	Eastern Pacific Shipping	DongHwa Entec	2020	Cryogenic Needle Valves, Gate / Globe Valves
SINOKOR 300K VLCC LNG TANK	Various	Sinokor Merchant Marine	SHI(Nantong CIMC SOE)	2020	Top Entry Cryogenic Ball Valves, Cryogenic Needle Valves, Cryogenic Swing Check Valves
OA DF A-MAX 10 VESSELS	Various	Sinokor Merchant Marine	SHI(Nantong CIMC SOE)	2020	Top Entry Cryogenic Ball Valves, Cryogenic Needle Valves, Cryogenic Swing Check Valves
K-LINE 80K LNG CARRIER	Various	K-LINE (Kawasaki Kisen Kaisha, Ltd.)	Hudong-Zhonghua Shipbuilding (KOCEAN)	2020	2-way Manifold Valves, 5-way Manifold Valves
15000 TEU Retrofit at HZ	Various	Hudong-Zhonghua Shipbuilding	Hudong-Zhonghua Shipbuilding (KOCEAN)	2020	2-way Globe Control Valves, Full Bore Type Safety Relief Valves, Safety Relief Valves, High-pressure Ball Valves, High-pressure Check Valves

Reference_ Offshore & Shipbuilding

Offshore & Shipbuilding

PROJECT	LOCATION	OWNER	CLIENT	YEAR	ITEM
DELOS 90K LPG LFSS SYS. & LPG Tank	Various	Delos Shipping	HHI(HSHI)	2020	Top Entry Cryogenic Ball Valves, Cryogenic Needle Valves, Cryogenic Swing Check Valves
174K Liquefied Natural Gas Carriers & FSRU	Various	BW Group	DSME(JEON-JIN)	2020	Cryogenic Ball Valves, Instrument Two Piece Ball Valves
Maran Gas 174K CBM LNG carrier	Various	Maran Gas Maritime Inc.	DSME(JEON-JIN)	2020	Cryogenic Ball Valve, Instrument Two Piece Ball Valves
ZVEZDA 50K P/C TANKER	Various	SOVCOMFLOT	HMD(Young Kwang Machine)	2020	2-pc Casting Ball Valves, 3-pc Ball Valves, Cryogenic Butterfly Valves, Remote Valves, Cryogenic Stop Check Valves, Gauge Block Valves
20,000 DWT Class Roll-on / Roll-off Carrier	Various	CLdN	HMD(Young Kwang Machine)	2020	2-piece Ball Valves, Butterfly Valves, Cryogenic Needle Valves, Gate & Globe Valves, Non-cryogenic Needle Valves, Safety Relief Valves, Stop Check Valves
Avance Gas Orders 91,000 cbm LPG VLGCs	Various	Avance Gas Holding	DSME	2020	Barstock Needle Valves, Non-cryogenic Needle Valves
ZVEZDA 50K P/C TANKER	Various	SOVCOMFLOT	HHI (DongHwa Entec)	2020	2-PIECE Ball Valves, Butterfly Valves, Casting Ball Valves, Swing Check Valves Top Entry Cryogenic Ball Valves, Cryogenic Globe & Needle Valves, Cryogenic Lift Check Valves, Cryogenic Swing & Stop Check Valves, Gate & globe Valves, Needle Valves, SDNR Check Valves,
JUPITER 174K LNGC	Various	Meridian	SHI (DongHwa Entec)	2020	Cryogenic Needle Valves, Gate Valves
Meridian 174K LNGC	Various	Meridian	SHI (DongHwa Entec)	2020	Cryogenic Needle Valves
TUG BOAT FGSS	Various	KOGAS MARINE	DongHwa Entec	2020	Cryogenic Ball Valves, Cryogenic Globe & Needle Valves, Lift & Swing Check Valves

PROJECT	LOCATION	OWNER	CLIENT	YEAR	ITEM
J420004 12K Bunkering System	Various	Pavilion Energy (Sembcorp Marine)	DongHwa Entec	2020	Cryogenic Globe & Needle Valves, Gate Valves
H-LINE 180,000 DWT BULK CARRIER FGSS	Various	H-LINE	DongHwa Entec	2020	Butterfly Valves, Cryogenic Globe Valves, Cryogenic Needle Valves, Cryogenic Stop Check Valves (SNDR), Globe Valves, SNDR Check Valves
EPS 110K COT Bunkering Station& LNG TANK, FGSS	Various	Eastern Pacific Shipping	DongHwa Entec	2020	Cryogenic Ball/Butterfly Valves, Cryogenic Lift Check Valve, Cryogenic Needle Valve, Cryogenic Stop Check Valve, Cryogenic Swing Check Valve, Globe Valve
98,000 m3 Ethane LPG carrier	Various	HHI/SATELLITE	HHI	2020	Cryogenic Globe Valves, Globe Valves, Safety Relief Valves, Lift Check Valves
ZVEZDA 50K P/C TANKER	Various	SOVCOMFLOT	HHI	2020	3-piece Ball Valves, Cryogenic Ball/Butterfly Valves, Cryogenic Globe / Needle Valves, Cryogenic Swing Check Valves
25K PC Tanker Bunkering Station& LNG Tank	Various	JP Morgan	HHI	2020	Cryogenic Remote Globe/Butterfly /Remote Butterfly/Ball/Globe/Lift Check /Needle Valves
25K PC Tanker FGSS & Bunkering Station	Various	JP Morgan	HHI (Sunbo Industries)	2020	Cryogenic SDNR/Globe/Needle Valves
180,000 DWT Class Bulk Carrier	Various	H-Line Shipping	HSHI	2019-2020	Cryogenic Top Entry Ball Valves
Maran Gas 174K LNGC	Various	Maran Gas	DSME (PTK)	2019	Cryogenic Ball Valves, Cryogenic Safety Relief Valves
			DSME (Sunbo Industries)	2019	Swing-out Ball Valves

Reference_ Offshore & Shipbuilding

PROJECT	LOCATION	OWNER	CLIENT	YEAR	ITEM
MOL 174K LNGC (X-DFI) Cargo System	Various	MOL	DSME (Core Plant)	2019	Cryogenic Ball Valves
			DSME	2019	Globe Valves; Cryogenic Needle Valves
			DSME (IDSSW)	2019	Cryogenic Globe/Needle Valves
Temile 22.8K LPGC	Various	Temile	HMD	2019	Instrument Ball Valves
Navigare 174K	Various	Navigare Capital	SHI (Centra)	2019	2-piece Casting Ball Valves
Nisshin 174K LNGC	Various	Nisshin Shipping	SHI (Centra)	2019	2-piece Casting Ball Valves
SCORPIO 19,500TEU CNT	Various	SCORPIO SHIP	SHI (VTL)	2019	2-piece Casting Ball Valves
Liquefaction System for LNG Pilot Plant	Various	SHI	Sunbo Industries	2019	Ball Valves; DBB Valves, SBB Valves, Trunnion Ball Valves, Cryogenic DBB/SBB/Ball Valves
Golar Gimi FLNG	Singapore	Golar LNG	Inoxciva, Kepple Fels	2019	Cryogenic Valves
King's Quay FPS	USA	LLOG Exploration	HHI	2019	Ball Valves (3" to 16", up to CL1500)
KOGAS 174K LNGC Cryo. Fitter System (MEGI)	Various	KLC, SK SHIPPING	DSME (Core Plant)	2019	Cryogenic Ball Valves
Dorian 84K LPGC	Various	Dorian Corporate Guarantees	DSME (DongHwa Entec)	2019	Globe Valves
Seatankers 173K LNG Carrier	Various	Sea Tankers	DSME (Sunbo Industries)	2019	Swing-out Ball Valves, Ball Valves (1-pc, DIN), Cryogenic Lift check, Swing check Valves, Globe/Gate/Butterfly Valves; Instrument Valves, Check Valves (Pan, Swing, Dual Plate)
Seatankers 174K LNGC	Various	Sea Tankers	DSME (Core Plant)	2019	Cryogenic Ball Valves
			DSME (Jeon-Jin)	2019	Cryogenic Valves (Ball, Safety Relief), Instrument Valves
SK 174K KC-1 (for KOGAS)	Various	SK SHIPPING	SHI (Core Plant)	2019	Cryogenic Ball Valves

Reference_ Offshore & Shipbuilding

PROJECT	LOCATION	OWNER	CLIENT	YEAR	ITEM
200K LNGC Cargo System	Various	Dynagas LTD	HHI	2019	Cryogenic Trunnion Ball Valves, Cryogenic Ball Valves
98,000 m3 Ethane/LPG Carrier	Various	DELOS	HHI	2019	Cryogenic Globe Valves, Globe Valves, Safety Relief Valves, Lift Check Valves
14,700 TEU Container Carrier	Various	EPS (Eastern Pacific Shipping)	HSHI (Donghwa Entec)	2019	Cryogenic Needle Valves, Gate/Globe Valves, Bar Stock Needle Valves
170K FSRU	Various	Türkiye Petrolleri a.o	HHI (DongHwa Entec)	2019	Cryogenic Needle Valves, Gate Valves, Bar Stock Needle Valves
			HHI (Young Kwang Machine)	2019	Ball Valves, Globe Valves, Gate Valves
173,400 CBM LNGC	Various	Maran Gas Andros	DSME (Young Kwang Machine)	2019	DBB Valves, Ball Valves, Cryogenic Ball/Gate /Lift Check Valves, Globe Valves, Gate Valves
Celsius 180K LNGC	Various	Celsius Shipping	SHI (Centra)	2019	2-piece Casting Ball Valves
			SHI (DongHwa Entec)	2019	Cryogenic Needle & Globe Valves
173,400 CBM LNGC	Various	Alpha Gas S.A.	DSME (Young Kwang Machine)	2019	DBB Valves; Ball Valves, Cryogenic Ball/Gate/Lift Check Valves, Globe Valves, Gate Valves
JAWA 170K FSRU	Various	PERTAMINA	SHI	2018-19	DBB Valves (#600 8" & 16")
ENI Coral FLNG	Various	Coral FLNG S.A.	SHI (Scana Korea)	2019	DBB Valves, SBB Valves, Instrument Valves, Instrument Ball Valves (2-piece, DIN, Ball Valves)
			SHI (DongHwa Entec)	2018	SBB Valves, Ball & Gate Valves, Barstock Needle Valves
KOGAS 7.5K LNG Carrier (KC-1)	Korea	KOGAS	SHI (Centra)	2018	Cryogenic Ball Valves
			Korea Line Corp (DongHwa Entec)	2018	Cryogenic Globe/Needle Valves, Gate Valves, Bar Stock Needle Valves

Reference_ Offshore & Shipbuilding

Offshore & Shipbuilding

PROJECT	LOCATION	OWNER	CLIENT	YEAR	ITEM
170K-Turkey FSRU	Various	Kolin/Kalyon	HHI (Sunbo Industries)	2018	Gate Valves, Globe Valves, Lift/Swing/Integral Bonnet Check Valves, Two Piece Ball Valves
173K LNGC Sea tanker	Various	Flex LNG	DSME (Core Plant)	2018	Cryogenic Ball Valves
180K LNG	Various	Knutsen	HHI (DongHwa Entec)	2018	Cryogenic Globe/Needle Valves, Cryogenic Lift Check, SDNR Valves, Ball/Globe/Gate Valves, Stop-check Valves; Instrument Valves
180K LNG	Korea	SK shipping	HHI (Hansuk Int'l, Kobe Steel)	2018	Dual Plate Check Valves
180K LNG KNUITSEN	Various	Knutsen	HHI (DongHwa Entec)	2018	Cryogenic Globe/Gate/Needle Valves, Cryogenic Lift check/SDNR/Ball Valves Cryogenic Bar Stock Needle Valves
180K LNG MOL	Various	MOL	DSME (DongHwa Entec)	2018	Cryogenic Ball Valves
260ton LNG Fuel Cleaning Ship	Various	UROOF (Ulsan Regional Office of Oceans & Fisheries)	Sunbo Industries	2018	Cryogenic Ball/Globe/Gate Valves, Cryogenic Life check Valves, Two piece ball Valves
26K FSRU Paxocean Zhoushan H1028	Liberia	PAXOCEAN	DongHwa Entec	2018	Cryogenic Globe, Bar-stock Needle Valves
7.5K LNG Bunkering Vessel	Various	Bernhard Schulte	HMD	2018	Cryogenic Ball Valves
325K VLOC Marine De-Sox	Various	Marine De-Sox	HSHI (Panasia)	2018	Gauge Root Valves
BW Gas 173K LNGC	Various	BW Gas	DSME (Dongwha Entec; Sunbo Industries)	2018	Cryogenic Ball Valves
EON-MOL 180K LNG Carrier	Various	MOL	DSME (Sunbo Industries)	2018	Gate Valves
1,800TEU CNTR Marine De-Sox	Various	Marine De-Sox	HMD (Panasia)	2018	Gauge Root Valves

PROJECT	LOCATION	OWNER	CLIENT	YEAR	ITEM
114K COT SOVCOMFLOT	Various	SOVCOMFLOT	HSHI (Sunbo Industries)	2018	Cryogenic Ball/Globe/Gate Valves, Cryogenic Needle/SDNR Valves, Swing Check, SDNR, Two-piece Ball Valves
			HHI (Sunbo Industries)	2017- 2018	Cryogenic Ball/Globe/Gate Valves, Cryogenic Needle/SDNR Valves, Swing Check; SDNR, Bar stock Needle Valves
174K LNG Carrier HI-ERS	Various	Teekay	HSHI (Sunbo Industries)	2018	Instrument Valves
			HSHI (DongHwa Entec)	2017	Cryogenic Ball/Globe Valves, 2-piece Casting/ Swing-out Ball/Globe/Gate Valves, Bar Stock, SDNR Check, Union Bonnet Needle Valves
KHI(S) 22N1743, 22N1745	Japan	Kawasaki Heavy Industries	Kawasaki Heavy Indus tries (BOGO)	2018	Needle Valves, High-pressure Ball Valves, Swing Check Valves, Stop Check Valves, Gate Valves, Globe Check Valves, Globe Valves
SK LNG	Various	SK shipping	SHI (Mt.H)	2018	Eccentricity Ball Valves
TDD GRS Drillship 3#	Various	Transocean Deepwater Drilling	DSME (GIO-DINTEC)	2018	DIN Ball/ISO 6164 Flanged Ball Valves, SAE J518 Flanged Ball Valves
Sampling Station in Unit-1600	Various	ADNOC REFINING (TAKREER)	SM Solution	2018	Gate/Lift Check Valves
Ichthys FPSO	Australia	INPEX Operations Australia Pty. Ltd.	DSME	2018	Ball Valves
KNC-1501 LNG JSK FRU	Indonesia	PEL (PT Pelabuhan I ndonesia)	Kangnam Corp. (DongHwa Entec)	2018	Cryogenic Globe, Bar-stock Needle Valves
SK shipping 180K LNG	Korea	SK shipping	HHI (Sunbo Industries)	2017	Cryogenic Gate/Globe/Needle Valves, Dual Plate Check Valves
TEEKAY ECC SHTL	Various	Teekay Shipping (Canada)	SHI	2017	High-pressure Ball Valves (3-way), SAE Flanges
OCEANRIG Drill Ship 10	Various	Ocean Rig	SHI	2017	Non return; 2-piece Casting Valves, /SAE J518 Flanged/Din Type/High-pressure Valves, SAE Flanged Check Valves, SAE Flanges
PETRONAS FLNG 2	Various	PETRONAS	SHI	2017	Flanged Ball Valves, SAE Flanges
BP SHIPPING 173K LNGC	Various	BP	DSME (Sunbo Industries)	2017	High Pressure Ball Valves

PROJECT	LOCATION	OWNER	CLIENT	YEAR	ITEM
50K Bulk Carrier	Korea	Ilshin Shipping	HMD	2017	Cryogenic Globe Valves
AET A-MAX	Various	AET Tanker Holdings	SHI (YoungKwang Machine)	2017	Cryogenic Needle Valves, Swing Check Valves 2-piece Casting Ball Valves, Needle/Globe/Gate/ Screw Down Non Return Valves
ASP 49K CT	Various	ASP	HHI (Scana)	2017	DIN Type Ball Valves
NASR 2	Various	ADMA-OPCO	HHI	2016	Single Block & Bleed Valves
MAN ME-GI Low Pressure Filter	Various	DSME, SHI	Korea-filter	2016	Cryogenic Needle, DBB, Ball, Globe Valves
Burckhardt Compression Vessel Skid	Various	Chandris Maran Gas	DSME, SHI	2016	Cryogenic Globe/Check/Globe Valves
Shell Prelude FLNG	Australia	Shell	SHI	2015	Flanged Ball/DBB Instrument Ball/Needle Valves DIN2353 Ball Valves
MOL LNG FSRU	Various	Mitsui O.S.K. Lines	DSME	2015	Cryogenic Ball/Globe/Check/Gate Valves
Nakilat MEGI Project	Various	MAN Diesel & Turbo	SHI	2015	Cryogenic Needle Valves
Ghana OCTP	Ghana	ENI – Gahna National Petroleum Company	Yingson Engineering	2015	Double Block and Bleed Valve (~2" CL2500)
HI-GAS Test Bed	Various	HHI	DongHwa Entec	2015	Cryogenic Globe Valves, Swing Valves
Höegh LNG	Various	Höegh LNG	HHI	2015	Cryogenic Needle Valves, Swing Valves
JSK PROJECT	Various	JSK CO.,LTD.	DongHwa Entec	2015	Cryogenic Globe Valves
KNUTSEN LNG FSRU	Various	Knutsen	HHI	2015	Cryogenic Ball/Globe/Check/Gate Valves
EGINA FPSO	Nigeria	Total	SHI	2015	Ball Valves (~ 4" CL150 RF)
TEEKAY LNG CARRIER	Canada	Teekay	DSME	2014	Cryogenic Globe/Check Valves
ROYAL DUTCH SHELL FLNG	Various	SHELL	SHI	2014	Flanges, Hub & Blind - SAE, ISO & Special
Moho Nord FPU	Nigeria	Total	HHI	2014	Instrument Manifold 3-Valves (DBB Type)
FLNG	Various	PETRONAS	DSME	2014	Cryogenic Ball Valves; 2-piece Ball Valves
GAZPROM LNGF	Various	GAZPROM	HHI	2014	Cryogenic Needle Valves

Reference_ Offshore & Shipbuilding

PROJECT	LOCATION	OWNER	CLIENT	YEAR	ITEM
Burckhardt Compression Leak Gas & Oil Removal Skid	Various	Sea Tankers, SK Shipping, BW Fleet Management, KOGAS, Chandris, Maran Gas, Teekay	DSME, SHI	2014	Cryogenic Ball/Globe Valves, Single Block & Bleed Valves, DIN Type Ball Valves
Chevron LNG	Various	Chevron	SHI	2014	Flange with U-Type Quick Coupling
NASSCO FGSS	U.S.A	NASSCO	DSME	2013	Cryogenic Ball/Globe/Check/Butterfly Valves
Semi Submersible Rig	Norway	Fred. Olsen Energy ASA	HHI	2012	DIN Tube Fitting
NOCC OCEANIC TRIAL	Norway	Norwegian Car Carriers ASA	HHI	2012	Pipe Fittings
Perusahaan Gas Negara FSRU	Indonesia	Höegh LNG	HHI	2012	Pipe Fittings
LNG Carriers	Greece	Dynagas Ltd	HHI	2012	Tube Fittings
LPG TANKER	Norway	SK Shipping	HHI	2012	Forged Fittings
ETESCO – PETROBRAS	Brazil	Etesco Brasil, LTD	SHI	2012	Flange, Hub & Blind - SAE & ISO, Tube Fittings (DIN Bite-type)
Goliat FPSO	Norway	ENI Norge	HHI	2012	Titanium Fittings
AB Klaipėdos Nafta FSRU	Lithuania	Höegh LNG	HHI	2012	Pipe Fittings
Ddrill Ship TBN	U.S.A	Rowan Companies	HHI	2012	Pipe Fittings
Drill Ship	U.S.A	Diamond Offshore	HHI	2012	Tube Fittings
Drill Ship	Greece	Noble Energy	HHI	2012	DIN Tube Fitting, High Pressure Fittings, High Pressure Bar Stock Needle Valves, P.S.V Valves
STENA Drilling Drill Ship	Various	STENA DRILLING	SHI	2011	Flange, Hub & Blind - SAE & ISO, Bite-type Fittings (DIN), High Pressure Fittings (Cone & Threaded connection)
STENA Semi-Rig	Various	STENA DRILLING	SHI	2011	Flange, Hub & Blind - SAE & ISO, Bite-type Fittings (DIN), High Pressure Fittings (Cone & Threaded connection)
VANTAGE Drill Ship	Various	Vantage Drilling Company	DSME	2011	ANSI Flanged & SAE Flanged Ball Valves, Ball & Spring Check Valves (DIN Bite-type), SAE Flange & Tube Fitting & Forged Fittings, Gauge Root Valves

Reference_ Offshore & Shipbuilding

PROJECT	LOCATION	OWNER	CLIENT	YEAR	ITEM
OCEAN RIG Drill Ship #5~8	Various	Ocean Rig	SHI	2011	Ball & Check Valves; DIN Tube Fittings Instrument Manifold Tube Fittings & Valves, High Pressure Fittings (Cone & Threaded),
Odebrecht Drillship # 1 & 2	U.S.A	Odebrecht	DSME	2011	Tube Fittings; Forged Fittings, Instrument Valves and Manifolds, Flanges
Pacific Drilling Drill Ship #3~8	Various	Pacific Drilling	SHI	2011	Ball & Check Valves; DIN Tube Fittings, Instrument Manifold Tube Fittings & Valves, High Pressure Fittings (Cone & Threaded)
QGOG Drill Ship #1~3	Various	QGOG Constellation	SHI	2011	Flange, Hub & Blind - SAE & ISO, High Pressure Fittings (Cone & Threaded connection)
SCHAHIN Drill Ship #1	Various	SCHAHIN Drill	SHI	2011	Tube Fittings (DIN Bite-type)
SEADRILL #4 & 5	Various	Seadrill	SHI	2011	Ball & Check Valves; DIN Tube Fittings, Instrument Manifold Tube Fittings & Valves, High Pressure Fittings (Cone & Threaded)
MAERSK Drill Ship	Various	Transocean Deepwater Drilling	DSME	2011	ANSI Flanged & SAE Flanged Ball Valves; SAE Flanges, Ball & Spring Check Valves (DIN Bite-type), Tube Fittings; Forged Fittings; Gauge Root Valves
MAERSK Drill Ship # 1~4	Various	Maersk Oil	SHI	2011	Ball & Check Valves, DIN Tube Fittings, Instrument Manifold Tube Fittings & Valves, High Pressure Fittings (Cone & Threaded)
ENSCO Drill Ship #3~10	Various	ENSCO	SHI	2011	Flange, Hub & Blind - SAE & ISO, Tube Fittings (DIN Bite-type)
GAZTRANSPORT & TECHNIGAZ	Various	GAZTRANSPORT & TECHNIGAZ (GTT)	SHI	2011	Flanges, Hub & Blind - SAE & ISO
GVA 7,500 SEMI RIG	Mexico	R. S.A. De C.V	DSME	2011	Tube Fittings, Forged Fittings, Instrument Valves and Manifolds, Flanges
ATWOOD Drill Ship	Various	Atwood Oceanics	DSME	2011	ANSI Flanged & SAE Flanged Ball Valves, SAE Flanges, Ball & Spring Check Valves (DIN Bite-type), Tube Fittings; Forged Fittings, Gauge Root Valves
CARDIFF Drill Ship #1~4	Various	CARDIFF	SHI	2011	Flanges, Hub & Blind - SAE & ISO, Tube Fittings (DIN Bite-type)
TMT Drillship #1	Marshall Island	Madarin Drilling Co.	DSME	2010	Tube Fittings, Forged Fittings, Instrument Valves and Manifolds, Flanges

Reference_ Oil & Gas

PROJECT	LOCATION	OWNER	CLIENT	YEAR	ITEM
Jafurah Gas Compression Plant Pkg 1	Saudi Arabia	SAUDI ARAMCO	Laesen & Toubro	2023	Tubes
Marjan Gas Treat Sufer Recovery Pkg 10	Saudi Arabia	SAUDI ARAMCO	Saipem Spa	2023	Tubes and Tube Fittings, Instrument Valves
Jafurah Utilities, Sulfur and Inter connecting Systems (PKG3)	Saudi Arabia	SAUDI ARAMCO	Hyundai Engineering Co.,Ltd.	2023	Tubes
				2023	Tube Fittings
Jafurah Gas Processing Facilities Project(PKG1)	Saudi Arabia	SAUDI ARAMCO	Samsung Engineering	2023	Tubes and Tube Fittings
Korea Energy Terminal PJT	ULSAN, Korea	KET (Korea Energy Terminal)	DAWOO E&C	2022	Cryogenic Forged DBB Valves, Forged DBB Valves
Basrah Refinery Upgrading Pjt	Iraq	South Refineries Company	Japan Gas Corporation	2022	Tubes and Tube Fittings, Instrument Valves
Saudi Aramco Modular Skid LTA	UAE / Saudi Arabia	Saudi Aramco	Petronash / Bousted Habu Engineering	2022	Tube Fittings, Instrument Valves
SASA New PTA Complex	Turkey	SASA Polyester	Tecnicas Runidas	2022	Instrument Tube Fittings and Valves, Seal ports, Seamless Tubings Air distribution manifold Valves
Mabrouk North East Development Pjt - Expension	Oman	Shell Oman	PETROFAC INTERNATIONAL Ltd	2022	Tube
Senegal FPSO	Singapore	Woodside	MODEC	2021	DBB Valves
MELAKA REFINERY DIESEL EU RO 5 PROJECT	Malaysia	PETRONAS PENAPISAN (MELAKA) SDN BHD	Hyundai Engineering Co.,Ltd.	2021	Flush Ring Kits
Nexlene Plant 1st Value up (Step1) EPC Project	Ulsan, Korea	Korea Nexlene Company	SK E&C	2019~2021	Tubes and Tube Fittings
KANGAN Olefin Project	Iran	KPDC	Namavarani Delvar E&C Energy Industries Co	2021	DBB Valves & SBB Valves
BAPCO PROJECT	Bahrain	The Bahrain Petroleum Company (Bapco)	TTSJV W.L.L.	2020	Tube and Tube Fittings, PITs
ULSAN PP PROJECT	Ulsan, Korea	ULSAN PP	SK E&C	2020	Tube and Tube Fittings Condensate Pots, PITs

Reference_ Oil & Gas

PROJECT	LOCATION	OWNER	CLIENT	YEAR	ITEM
ULSAN PP PROJECT	Ulsan, Korea	ULSAN PP	SK E&C	2020	Tube and Tube Fittings Condensate Pots, PITs
SBPL 500MW CFPP PROJECT	Philippines	SAN BUENAVENTURA POWER LTD. CO.	Daelim Industrial	2020	Tube and Tube Fittings, Needle Valves
Longson Petrochemical Complex (VLSU)	Vietnam	Long Son Petrochemicals Co., Ltd.	Hyundai Engineering Co.,Ltd.	2020	Pipes and Pipe Fittings
MFC PROJECT	Yeosu, Korea	GS Caltex Corporation	GS E&C	2020	Condensate Pots
Mabrouk North East Development Project,	Oman	PDO	PETROFAC INTERNATIONAL Ltd	2020	Tubes
Thai Oil CFP	Thailand	Thai Oil Public Company Limited	PETROFAC INTERNATIONAL Ltd	2020	Tubes, Tube fittings
MFC PROJECT	Yeosu, Korea	GS Caltex Corporation	GS E&C	2019~ 2020	Tubes, Tube fittings
ERC PROJECT	Qalyoubgia, Egypt	EGYPTIAN REFINING COMPANY (TAKRIR) S.A.E	GS E&C	2019	Pressure Relief Valves
PETRONAS KERTIH 01- K-0998	Korea	PETRONAS	Turcomp Engineering Services Sdn Bh	2020	Cryogenic Ball Valves, Cryogenic Gate Valves
BAPCO PROJECT	Bahrain	The Bahrain Petroleum Company (Bapco)	TTSJV W.L.L.	2020	Tube and Tube Fittings, PITs
ULSAN PP PROJECT	Ulsan, Korea	ULSAN PP	SK E&C	2020	Tube and Tube Fittings Condensate Pots, PITs
SBPL 500MW CFPP PROJECT	Philippines	SAN BUENAVENTURA POWER LTD. CO.	Daelim Industrial	2020	Tube and Tube Fittings, Needle Valves
Longson Petrochemical Complex (VLSU)	Vietnam	Long Son Petrochemicals Co., Ltd.	Hyundai Engineering Co.,Ltd.	2020	Pipes and Pipe Fittings
MFC PROJECT	Yeosu, Korea	GS Caltex Corporation	GS E&C	2020	Condensate Pots

Reference_ Oil & Gas

PROJECT	LOCATION	OWNER	CLIENT	YEAR	ITEM
Mabrouk North East Development Project	Oman	PDO	PETROFAC INTERNATIONAL Ltd	2020	Tubes
Thai Oil CFP	Thailand	Thai Oil Public Co., Ltd.	PETROFAC INTERNATIONAL Ltd	2020	Tubes, Tube fittings
MFC PROJECT	Yeosu, Korea	GS Caltex Corporation	GS E&C	2019~2020	Tubes, Tube fittings
ERC PROJECT	Qalyoubgia, Egypt	EGYPTIAN REFINING COMPANY(TAKRIR) S.A.E.	GS E&C	2019	Pressure Relief Valves
No.2 PX PSA Requidation and New PSA Project	Ulsan, Korea	SK Global Chemical	SK E&C	2019	Tubes, Tube fittings
LPIC	Oman	ORPIC	GS E&C	2019	DBB Valves
ADNOC Integrated Gas Field Development - Expansion	UAE	ADNOC (Abu Dhabi National Oil Company)	Tecnicas Reunidas	2019	Seamless Tubing
ADNOC Bu-Hasa Field Development	UAE	ADNOC (Abu Dhabi National Oil Company)	Tecnicas Runidas	2019	Instrument Tube Fittings & Valves, Seal ports, Seamless Tubing, Air distribution manifolds
Golar Gimi FLNG	Singapore	Golar LNG	Inoxciva, Kepple Fels	2019	Cryogenic Valves
Lekhwaier RMS-12 DD	Oman	PDO (Petroleum Development Oman)	Fast Line Technical Service	2019	Tubes; Tube Fittings, Instrument Valves; Manifolds
Garraf Oil Train 3, 4, 5	Iraq	Petronas Carigali Iraq	CPECC (China Petroleum E&C Corporation) Middle East	2019	Tubes; Tube Fittings, Instrument Valves, Manifolds
No.2 CDU Project	Korea	SK Energy	SK E&C	2019	Tubes; Tube Fittings
S-Project	Korea	SK Energy	SK E&C	2019	Tubes; Tube Fittings
Mozyr Refinery	Belorussia	SLAVNEFT	MNPZ	2019	Tube Fittings
UZGTL	Uzbekistan	GTL LLC	Hyundai E&C	2018	Tube Fittings
Jurassic Production Facilities Off-Plot Works	Kuwait	KOC	Emirates Electrical & Instrumentation	2018	Needle/Ball Valves, Tube Fittings

Reference_ Oil & Gas

PROJECT	LOCATION	OWNER	CLIENT	YEAR	ITEM
WEST QURNA-2	Iraq	Lukoil	77 İNŞAAT VE TAAHHÜT	2018	DBB Valves, Check / Gate Valves, Trunnion/Floating Ball Valves, Water/Swing/Lift Check Valves
Novatek Vysotsk LNG Plant	Russia	Lukoil	Novatek	2018	DBB Valves, SBB Valves
Karbala	Iraq	SCOP	Hyundai E&C	2018	Tubes, Pits, Tube Fittings
MDE5	Malaysia	SDN BHD	Hyundai E&C	2018	Pipes; Pipe Fittings
BeAAT Treatment Plant Expansion	UAE	TAKREER	METRADE	2018	Instrument Tube Fittings
Gas-to-Gasoline	Turkme-nistan	TURKMENGAZ	SKB PACIFIC	2018	Tube Fittings
Al-Zour Refinery Package #1, 2&3, 4	Kuwait	KNPC	Tecnicas Reunidas, Sinopec, Hanwha E&C, Saipem, Hyundai Eng.	2017-2018	Tube Fittings, Instrumentation Valves, Manifold valves, Monoflange valves, Block and Bleed Valves, Tubes
SIBA Field Development Project	Iraq	Basrah Oil / Kuwait Energy Limited Iraq	PETROSOLUTIONS (FZE)	2017	DBB Valves
NASR 2	Various	ADMA-OPCO	HHI (Hyundai Heavy Industries)	2016	Single Block & Bleed Valve
Rumaila Oil Field Development	Iraq	British Petroleum	CPECC (China Petroleum E&C Corporation)	2016	DBB valves, Monoflange valves
Sampal Compression Station	Indonesia	Conoco Phillips	PT. ReKayasa Industries	2016	Tube Fittings, Instrument Ball Valves, Flange Adaptors
EPC CPF Phase 2 at Badra Oilfield	Iraq	Gazprom	Samsung E&C	2016	Tube; Tube Fittings
KNPC Sulphur Handling Facilities Project (SHFP) at MAA Refinery	Kuwait	KNPC	Daelim Industrial	2016	Tube; Tube Fittings
KNPC Clean Fuel Project (CFP)	Kuwait	KNPC	GS E&C; SK E&C; Daewoo E&C; JGC Corp.	2016	Tube Fitting, Instrument Ball Valve
KOC Gather Center (GC-29)	Kuwait	KOC	Larsen & Toubro	2016	Tube Fittings, Instrument Ball & Needle Valves

Reference_ Oil & Gas

PROJECT	LOCATION	OWNER	CLIENT	YEAR	ITEM
KOC GC-28, 29 & 30	Kuwait	KOC	Petrofac; Larsen & Toubro; Dodsal	2016	DBB valves, Monoflange valves
H307 CR600 (Platform)	China	CIMC Raffels	CIMC Raffels	2015	Tube Fitting, Instrument Ball Valves
Liaohe, Dagang and Jidong Oil field Development	China	CNOOC (China National Offshore Oil Corporation)	Timeast Offshore	2015	Instrument Ball Valves
Ghana OCTP	Ghana	ENI – Gahna National Petroleum Company	Yingson Engineering	2015	Double Block and Bleed Valves (~2" CL2500)
Hebron DES Project	Canada	ExxonMobil	HHI (Hyundai Heavy Industries)	2015	High Pressure Fittings
Compressor Package A-3901	Oman	PDO (Petroleum Development Oman)	Leobersdorfer Maschinenfabrik	2015	Double Block & Bleed Valves
Petronas Floating Liquefied Natural Gas 1 (L) Ltd.	Malaysia	Petroliam Nasional Berhad	DSME	2015	Double Block & Bleed Valves
Shell Prelude FLNG	Australia	Shell	SHI	2015	Flanged Ball Valves, DBB Valves, Instrument Ball/Needle Valves, DIN2353 Ball Valves
BADAMYAR Project	Myanmar	Total	HHI (Hyundai Heavy Industries)	2015	Air Manifolds, Drain Pots
EGINA FPSO	Nigeria	Total	SHI	2015	Ball Valves (~ 4" CL150 RF)
Point Thomson Project	U.S.A	ExxonMobil	HHI (Hyundai Heavy Industries)	2014	Air Manifolds
FRIGSTAD SHEKOU (H1277)	China	Frigstad Offshore Ltd	Frigstad Offshore Ltd	2014	Tube Fittings, Instrument Ball & Needle Valves
FRIGSTAD KRISTIANSAND (H1278)	China	Frigstad Offshore Ltd	Frigstad Offshore Ltd	2014	Tube Fittings, Instrument Ball & Needle Valves
Moho Nord FPU	Nigeria	Total	HHI (Hyundai Heavy Industries)	2014	Instrument Manifold 3-Valves (DBB Type)
Jurong Refinery Expansion	Singapore	Chevron	Foster Wheeler	2012	Tube Fittings
KNPC Pipeline Project	Kuwait	KNPC	Hyundai E&C	2012	Gate Valves, Needle Valves, Ball Valves

Reference_ Oil & Gas

PROJECT	LOCATION	OWNER	CLIENT	YEAR	ITEM
KOC Pipeline Project	Kuwait	KOC	Hyundai E&C	2012	Gate Valves, Needle Valves, Ball Valves
Hai Thach FSO	Vietnam	Petro Vietnam	National Oilwell Varco	2012	DBB Valves, Flanged Ball Valves
P-61 Platform	Brazil	Petrobras	FloaTec	2012	Instrument Air Manifolds, Instrument Valves and Manifolds
Mehar Gas Development	Pakistan	Petroliam Nasional Berhad	SPEC International	2012	Tube Fittings, DBB Valves, SBB Valves, Instrument Valves and Manifolds
Ammonia / Urea Expansion Project	U.A.E	Fertil	Samsung E&C	2011	Tube Fittings, Pipe Fittings
New Booster Station 160	Kuwait	KOC	Saipem	2011	Tube Fittings, Instrument Valves, Tubes, Pipes, Flanges
Arabian Chlor Vinyl (CA/EDC) Plant	Saudi Arabia	SAHARA ACVC	Daelim E&C	2011	Instrument Air Manifolds
E8K & F13K Compression	Malaysia	Shell	Worley Persons	2011	DBB Valves (Fugitive Emission)
KNPBG-B	Malaysia	Petroliam Nasional Berhad	Malaysia Marine & Heavy Industry	2010	DBB Valves (Fugitive Emission)
F6 REJUV	Malaysia	Shell	Kencana Petroleum	2010	DBB Valves
3 years Price Agreement	Indonesia	Conoco Phillips	N/A	2009	Tube Fittings, Pipe Fittings
Cili Padi gas field Development	Malaysia	Shell	Technip	2009	DBB Valves (Chemical Injection/Sampling Probe)
CLOV FPSO	Angola	Total	DSME	2009	DBB Valves, Instrument Valves, Manifold Valves
PAZFLOR FPSO	Angola	Total	DSME	2008	Instrument Valves and Manifolds
Umm Sharif Field Development	U.A.E	ADMA-OPCO	HHI (Hyundai Heavy Industries)	2007	Tube Fittings, Instrument Valves, Brackets, Clamps

Reference_ Nuclear

PROJECT	LOCATION	OWNER	CLIENT	YEAR	ITEM
Barakah NPP	U.A.E	Nawah Energy	Hyundai E&C	2023	Flexible Hoses
			KHNP	2023	Flexible Hoses
			KHNP	2022	Flexible Hoses
		KHNP	Daedong Rise	2022	Caps
		Emirates Nuclear Energy Corporation	Hyundai E&C	2020	Flexible Hoses
			Hyundai E&C	2018	Pipes; Tube Fittings
			Hyundai E&C	2017	Tube Fittings
			Hyundai E&C	2013	Intake Air Duct Spools, Exhaust Gas Pipe Spools, Air Intake Reducers, Flexible Hoses, Gallery
			Doosan HIC	2013	Flanges, Tube Fittings
			Hyundai E&C	2012	Tube Fittings, Forged Fittings, Pipe Fittings, Tubes, Pipes
Hanbit (Yonggwang) NPP	Korea	KHNP	CheonSoo ENG	2023	Quick Connectors
			KHNP	2022	Seamless Pipes
			Doosan Enerbility	2022	BW Fittings, Plates
			Daewoo E&C	2022	Elbow BW Fittings
			Doosan HIC	2022	Pipe Fitting, Flange, Plate, Pipe
			KHNP	2020	Pipe Fitting
			MooJin	2020	Pipe Fitting, Flange
			Daeelim	2020	Pipe Fitting
			KHNP	2019	Forged Fitting
			Daewoo E&C	2019	Tube Fitting, Pipe Fitting
			KHNP	2018-19	Tube Fitting (Monel)
			KHNP	2017	Tube Fitting (Monel), Tube
			Kepco KPS	2016	Forged Fitting, Pipe Fitting, Flange, Pipe
			KHNP	2016	Pipe, Tube, Forged Fitting, Pipe Fitting, Tube Fitting
			KHNP	2014	3-Way Manifold Valves, Instrument Valves, Union Bonnet Needle Valves, Tubes, U-GUIDEs
KHNP	2013	Tube Clamps			



Reference_ Nuclear

PROJECT	LOCATION	OWNER	CLIENT	YEAR	ITEM
Hanul (Uljin) NPP	Korea	KHNP	KHNP	2023	Anchor Bolts
			KEPCO	2023	Seamless Pipes, Plates Etc.
			KHNP	2022	Anchor Bolts, Pipes
			Moojin	2022	BW Fittings
			Flowserve Korea	2022	Nipples, Plugs
			KEPCO	2022	Seamless Tubes, Flanges, SW Fittings, Plate Etc.
			KPS	2020	Pipe Fittings
			KHNP	2020	Flanges
			KHNP	2019	Pipe Fittings, Bolts & Nuts, Pipes
			KHNP	2018	Unistrut Channels (with 3/8" Bolt, Nut, Washer), CLP Plates
			KHNP	2017	Pipes, Tube Fittings
			Kepeco KPS	2017	Liner Plates
			Kepeco KPS	2016	28" Pipe Fittings
			KHNP	2016	Pipes, Pipe Fittings
KHNP	2011	Tube Fittings, Tube Clamps, Tubes, 3-Way Manifold Valves, Instrument Valves, Union Bonnet Needle Valves, ESW Pipe spools			
Shin-Kori NPP #5, 6	Korea	KHNP	HSD Engine	2023	Tube Clamps
			Samsung C&T	2023	BW Fittings
			Samsung C&T	2022	BW Fittings, Quick Connectors
			Moojin	2022	BW Fittings
			Samyoung Fitting	2022	Male Connectors
			HSD Engine	2022	Instrument Mounting Brackets
			My Tec	2022	Seamless Tubes, Valves, Fittings
			HSD Engine	2021	Socket Welding Thermowells
			Samsung C&T	2019-2020	Forged Fitting, Pipe Fitting
			HSD Engine	2019	Tube, Tube Fitting, Forged Fitting
LG Electronics (Samsung C&T)	2018	Pipe Fitting			

Reference_ Nuclear

PROJECT	LOCATION	OWNER	CLIENT	YEAR	ITEM
Kori NPP	Korea	KHNP	KHNP	2022	Seamless Tubes, Anchor Bolts
			Flowserve Korea	2022	Caps
			Doosan Enerbility	2022	SW Fittings, Seamless Pipes
			KEPCO KPS	2022	Seamless Pipes, SW Fittings
			KPS	2020	Pipe Fitting
			Doosan HIC	2020	Pipe Fitting
			KEPCO KPS	2018	Forged Fitting, Pipe
			KHNP	2018	Forged Fitting, Pipe Fitting, Flange, Pipe
			KHNP	2016	Forged Fitting, Pipe Fitting
			KHNP	2014	Tube Fittings, Tubes, Pipe Fittings, Pipes, U-GUIDEs Instrument Valves (Types: Manifold, Needle),
			KHNP	2013	Tube Fittings, Tubes, Integral Bonnet Needle Valves, Secondary Cooling Sea Water System Piping for Central Cooler
Saeul NPP	Korea	KHNP	KHNP	2023	Anchor Bolts
				2022	Anchor Bolts
			Moojin	2022	Stud Bolts, Nut Sets, BW Fittings
Kori NPP #3, 4	Korea	KHNP	Doosan HIC	2023	ICI Guide Tubes
			Doosan HIC	2019	Flanges, Pipe Fittings
Wolsong NPP	Korea	KHNP	KHNP	2022	Union Tee Fittings, Union Elbows
			KHNP	2022	Seamless Tubes
			Doosan HIC	2019	Pipes, Pipe Fittings
			KHNP	2019	Forged Fittings, Pipe Fittings
			KEPCO KPS	2018	Forged Fittings, Pipe Fittings, Pipes, Tube Clamps
			KHNP	2017	Pipes, Tubes, Forged Fittings
			KEPCO KPS	2016	Pipes, Forged Fittings
KHNP	2013	Tube clamps			

Reference_ Nuclear

PROJECT	LOCATION	OWNER	CLIENT	YEAR	ITEM
Kundankulam NPP	India	Nuclear power corporation of India LTD.	Hyundai Heavy Industries	2022	Flexible Hoses
Wolsong NPP	Korea	KHNP	KHNP	2020	Pipe Fittings
UK 5211	UK	EDF Energy	Hyundai E&C	2017-20	Brackets
Karachi (K2/K3) NPP	Pakistan	Pakistan Atomic Energy Commission (PAEC)	HHI	2017-19	Flexible Hoses
Shin-Hanul (Uljin) NPP #1 & 2	Korea	KHNP	Hyundai E&C	2018	Pipe, Pipe Fittings
China AP-1000 NPP	China	China National Nuclear Corporation	Westinghouse	2012	Tube Fittings, Tubes
Shin-Hanul (Uljin) NPP	Korea	KHNP	Hyundai E&C	2012	Instrument Fittings (Types: Tube/Forged/Pipe), Tubes, Pipes
Shin-Kori NPP #3, 4	Korea	KHNP	Hyundai E&C, D oosan HIC	2011	Tube Fittings, Tubes, Pipes
Shin-UlJin NPP #1 & 2	Korea	KHNP	Hyundai E&C	2011	Tube Fittings, Tubes, Pipes
Shin-Wolsong #1 & 2 NPP	Korea	KHNP	Samsung E&C	2011	Tube Fittings, Instrument Valves, Tubes, Pipes
Wolsong Waste Treatment	Korea	KHNP	N/A	2010	Tube Fittings, Tubes, Pipes

Reference_ Power Plant (other than Nuclear)

Power Plant (Other than Nuclear)

PROJECT	LOCATION	OWNER	CLIENT	YEAR	ITEM
PANAMA GATUN PJT	PANAMA	Generadora de Gatun	POSCO E&C	2023	Pipes and Pipe fittings, Tubes and Tube Fittings
MFC PROJECT	Yeosu, Korea	GS Caltex Corporation	GS E&C	2020	Tubes & Tube Fittings
SBPL 500MW CFPP PROJECT	Philippines	SAN BUENAVENTURA POWER LTD. CO.	Daelim	2020	Tubes & Tube Fittings, Needle Valves
Shin Seochon 1018MW Coal Fired Thermal Power Plant #1	Korea	Korea Midland Power	Daelim	2020	Ball Valves
Sulsel Barru-2 CFSP	Indonesia	PT PLN Persero	BHI (FLATDIS)	2019	Instrument Manifold Valves
Masinloc Power Station	Philippines	Masinloc Power Partners	POSCO E&C	2018	Tube Fittings
BIBIYANA-III, 400MW Combined Cycle P.P	Bangladesh	Bangladesh Power Development Board (BPDB)	SKB PACIFIC	2018	Tube Fittings
Goseong Hai Power Plant	Korea	KOEN (Korea South East Power)	DHI	2018	Tube Fittings, Instrument Valves
Doha SWRO Desalination Plant S1	Kuwait	MEW (Ministry of Electricity & Water)	DHI	2018	Tube Fittings, instrument Valves
Boryeong TPP #3	Korea	KOMIPO (Korea Midland Power)	DHI	2018	Forged Fittings
SEC 210 1x105MW Coal-Fired Power Project	Philippines	Sarangani Energy Corporation (SEC)	SKB PACIFIC	2018	Tube Fitting
Panama Colon Gas Project	Panama	AES	Posco E&C / Kumyang	2017	Tube, Tube Fittings
Botswana Morupule A Retrofit PJT	Botswana	Botswana National Energy Company (BPC)	DHI	2017	Integral Bonnet Needle Valves, Tubes, Tube Fittings
Hyundai Hi-Well Pump	Various	HHI	HHI	2017	SAE Flange Check Valves, SAE J518 Flanged Ball Valves, DIN Type Ball Valves
Yanbu 2 PKG1 PJT	Saudi Arabia	MARAFIQ	Hanwha E&C / OMC Corp.	2017	Union Bonnet Needle Valves, Tubes, Tube Fittings

Reference_ Power Plant (other than Nuclear)

Power Plant (Other than Nuclear)

PROJECT	LOCATION	OWNER	CLIENT	YEAR	ITEM
Doha SWRO Desalination Plant	Kuwait	MEW (Ministry of Electricity & Water)	DHI	2017	Instrument Valves and Manifolds, Tubes, Fittings
Fadhili CCPP	Saudi Arabia	SEC & Saudi Aramco	DHI	2017	Condensate Pots, Needle Valves, Tubes, Fittings
Facility D IWPP (Umm Al Houf Power)	Qatar	Kahramaa	HHI	2016	Tube Fittings, SMLS Tubes, Needle Valves, Manifold Valves
Mirfa IWPP Plant	U.A.E	ADWEA	HHI	2015	Tube Fittings, SMLS Tubes, Needle Valves, Gate Valves, Manifold Valves
PAGBILAO Project	Philippines	Aboitiz Power Corp.	HHI	2015	Tube Fittings, SMLS Tubes, Needle Valves, Manifold Valves (F51)
Shuqaiq Steam Power Plant	Saudi Arabia	Saudi Electricity Company (SEC)	HHI	2015	Tube Fittings
SEJONG Combined Heat and Power Plant	Korea	KOMPO	Doosan HIC	2013	Tube Fittings
Duvha Power Station	South Africa	Eskom	Siemens	2012	<i>i-fittings</i>
Sohar 2 & Barka III IPP	Oman	Oman Power and Water Procurement Co.	GS E&C	2012	Tube Fittings, Tubes
Rabigh Power Plant	Saudi Arabia	Saudi Electricity Company	Doosan HIC	2012	Tube Fittings, Pipe Fittings
YANGJU Combined Heat and Power Plant	Korea	SK E&S	Doosan HIC	2012	Tube Fitting s
Mong Duong Power Plant	Vietnam	VietNam Electricity	Doosan HIC	2012	Tube Fittings, Pipe Fittings
Medupi Power Station	South Africa	Eskom	Kentz E&C	2011	Tube Fittings
Shuaibah IWPP Expansion	Saudi Arabia	Saudi Electricity Company	Doosan HIC	2011	Tube Fittings, Pipe Fittings, Flanges
Marafiq IWPP	Saudi Arabia	Marafiq	Doosan HIC	2010	Tube Fittings, Pipe Fittings
Jebel Ali M Station	U.A.E	Dubai Electricity and Water Authority	HHI	2009	Tube Fittings

Reference_ Chemical & Petrochemical

PROJECT	LOCATION	OWNER	CLIENT	YEAR	ITEM
HYUNDAI CHEMICAL HPC	Korea	Hyundai Chemical	Daelim Industrial	2021	Tube, Tube Fittings, Instrument Valves
PETRONAS KERTIH 01- K-0998	Korea	PETRONAS	Turcomp Engineering Services Sdn Bh	2020	Cryogenic Ball & Gate Valve
HHYCO project HANWHA YEOSU 01	Korea	Hanwha Solutions/ Chemical	Turcomp Engineering Services Sdn Bh	2020	2,3-piece Ball Valve, Gauge Block Valve, Globe & Gate Valve, Lift Check Valve,
HYUNDAI CHEMICAL HPC	Korea	Hyundai Chemical	OTTE E&C / Daelim Industrial	2020	2,3-piece Ball Valve, Ball Valve, Gate & Globe Valve, Swing Check Valve
Yeosu 3NCC Project	Korea	LG Chem, Ltd.	GS E&C	2020	Globe & Gate Valve, Swing Check Valve, 2, 3-piece Ball Valve, High-pressure Ball Valve
MFC PROJECT	Korea	GS Caltex	GS E&C	2020	Condensate Pot, Tubes, Tube Fittings
K-10 Project	Korea	Hanwha Chemical	Hanhwa E&C	2019	Needle Valves
LSP Complex Project	Vietnam	Long Son Petrochemicals	Hyundai Engineering	2020	Pipes, Pipe Fitting
Nexlene Plant 1st Value up (Step1) EPC Project	Korea	Korea Nexlene Company	SK E&C	2019	Tubes, Tube Fittings
#2 PX PSA Requisition & New PSA Project	Korea	SK Global Chemical	SK E&C	2019	Tubes, Tube Fittings
EPO Project	Korea	Daelim Industrial	Daelim Industrial	2019	Tubes, Tube Fittings
Hanwha Daesan 01	Korea	Hanwha Total	Burckhardt Compression Korea Busan	2019	2- & 3-piece Ball Valves, Butterfly Valves, Dual Check Valves, Gate Valves, Globe Valves, Swing Check Valves
Ulsan PP #3	Korea	Ulsan PP	SK E&C	2019	2- & 3-piece Ball Valves, Globe Valves, Gate Valves, Swing Check Valves